

TOLERANCE UNLESS OTHERWISE SPECIFIED	
.X	±0.25
.XX	±0.13
.XXX	±0.05

THIS IS A C.A.D. GENERATED DRAWING
DO NOT MAKE MANUAL REVISIONS TO MASTER.

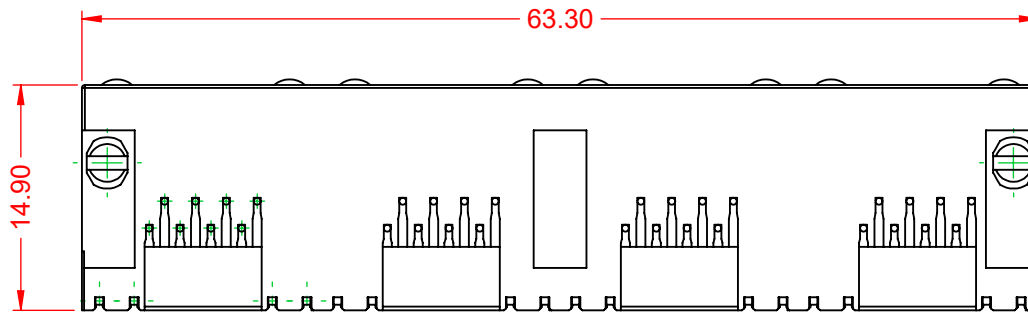

ISSUE NUMBER	1
ORIGINAL	

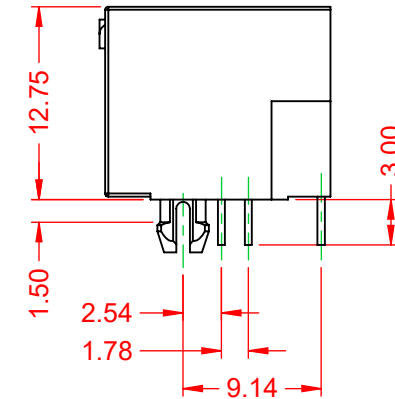
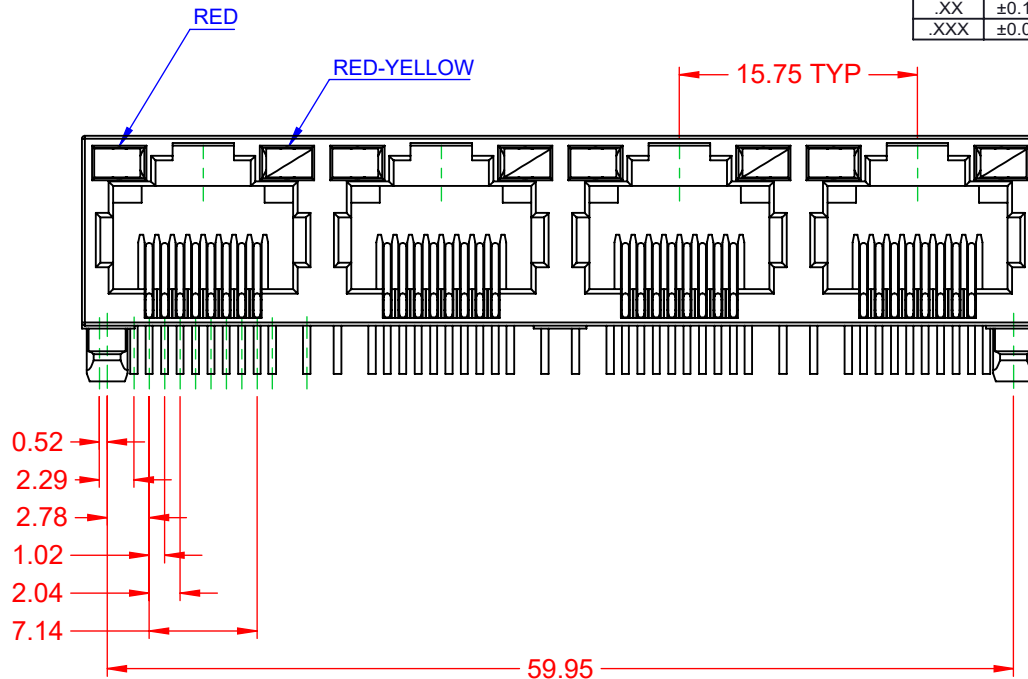

NOTES:

- MATERIALS:**
INSULATOR: PBT, BLACK, UL 94V-0
CONTACT: PHOSPHOR BRONZE, SELECT GOLD FLASH PLATING ON CONTACT AREA TIN ON TAILS OVER NICKEL
- VOLTAGE RATING:** 125 VAC RMS
- CURRENT RATING:** 1.5 AMPS @25°C
- CONTACT RESISTANCE:** 20mΩ MAX
- INSULATOR RESISTANCE:** 1000 MΩ MIN @ 500V DC
- DIELECTRIC WITHSTANDING:** 1000V AC CONTACT TO CONTACT OR 1500VDC CONTACT TO SCREEN AND TEST PANEL @0.5mA 50Hz OR 60Hz 60s
- DURABILITY:** 750 CYCLES MIN
- MATING/UNMATING FORCE:** 30N/3.06KG MAX
- RETENTION STRENGTH:** 30N MIN FOR 60s ±5s
- OPERATING TEMP:** -40°C TO +85°C
- STORAGE TEMP:** -40°C TO +85°C RELATIVE HUMIDITY <80%

MATES WITH MODULAR PLUG CONFORMING TO FCC PART 68, SUBPART F.



THIS SERIES FULLY CONFORMS TO
THE EUROPEAN UNION DIRECTIVES
2011/65/EU FOR RoHS COMPLIANCY.



YOUR CONNECTION TO QUALITY & SERVICE

EDAC INC
TORONTO, ONTARIO
CANADA

THESE DRAWINGS AND SPECIFICATIONS
ARE THE PROPERTY OF EDAC INC., AND
SHALL NOT BE REPRODUCED, OR COPIED
OR USED AS THE BASIS FOR THE
MANUFACTURE OR SALE OF APPARATUS
WITHOUT WRITTEN PERMISSION.

RJ45, w/LED, RIGHT ANGLE PCB MOUNT

ACAD REFERENCE NO.: J67 Assembly	
DRAWN: C.B	DATE: January 16, 2020
CHECKED:	DATE:
SCALE: 2:1	SHEET 1 OF 2
DRAWING NUMBER: J67 Assembly	ISSUE
PART NUMBER: J67048821P21011	1

TOLERANCE UNLESS OTHERWISE SPECIFIED	
.X	±0.25
.XX	±0.13
.XXX	±0.05

THIS IS A C.A.D. GENERATED DRAWING
DO NOT MAKE MANUAL REVISIONS TO MASTER.



ISSUE NUMBER	
ORIGINAL	①

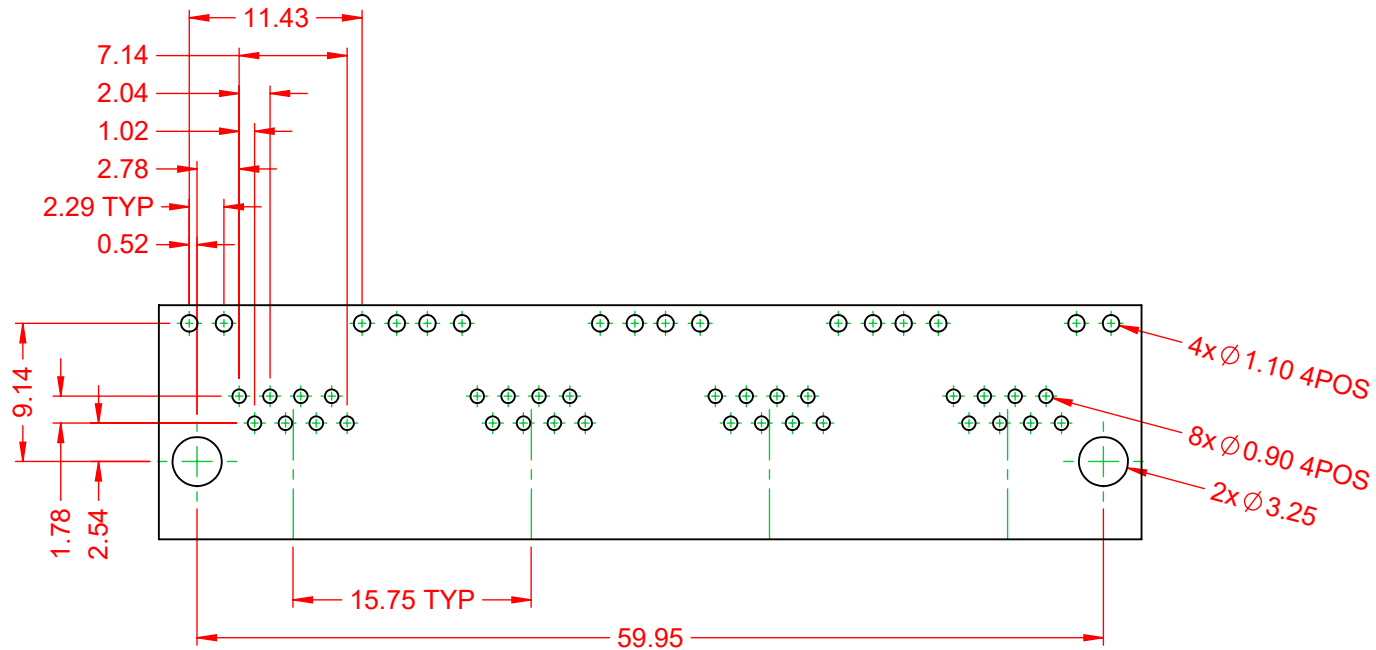

SUGGESTED PCB LAYOUT

RJ45, w/LED, RIGHT ANGLE PCB MOUNT	ACAD REFERENCE NO.: J67 Assembly	
	DRAWN: C.B	DATE: January 16, 2020
	CHECKED:	DATE:
	SCALE: 2:1	SHEET 2 OF 2
	DRAWING NUMBER: J67 Assembly	ISSUE
	PART NUMBER: J67048821P21011	1



THIS SERIES FULLY CONFORMS TO
THE EUROPEAN UNION DIRECTIVES
2011/65/EU FOR RoHS COMPLIANCY.



YOUR CONNECTION TO QUALITY & SERVICE

EDAC INC
TORONTO, ONTARIO
CANADA

THESE DRAWINGS AND SPECIFICATIONS
ARE THE PROPERTY OF EDAC INC., AND
SHALL NOT BE REPRODUCED, OR COPIED
OR USED AS THE BASIS FOR THE
MANUFACTURE OR SALE OF APPARATUS
WITHOUT WRITTEN PERMISSION.