

TOLERANCE UNLESS OTHERWISE SPECIFIED IN MM:
 0 ± 0.50
 0.0 ± 0.38
 0.00 ± 0.25
 0.000 ± 0.10

THIS IS A C.A.D. GENERATED DRAWING
 DO NOT MAKE MANUAL REVISIONS TO MASTER.

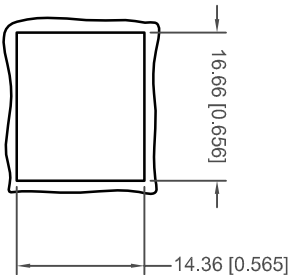

RECOMMENDED
 PANEL CUTOUT DIMENSION

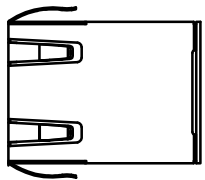
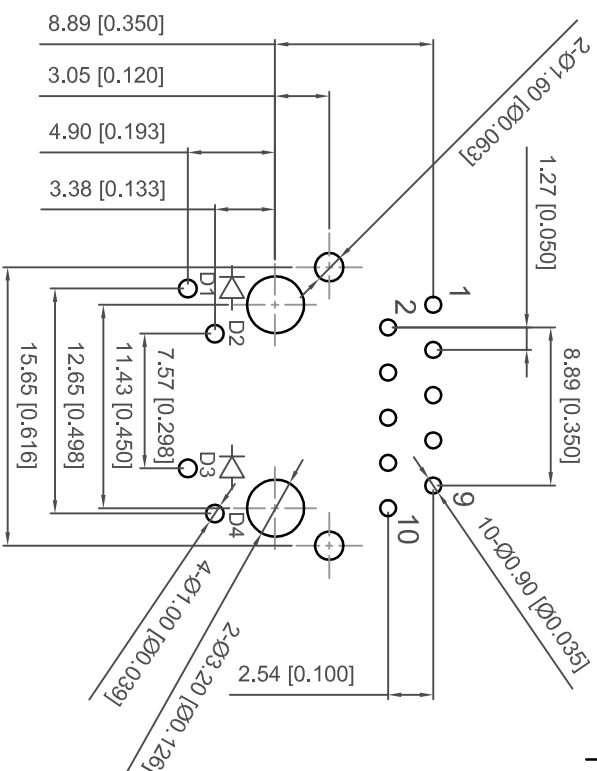
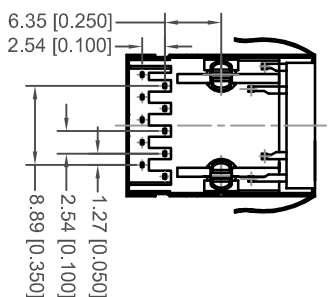
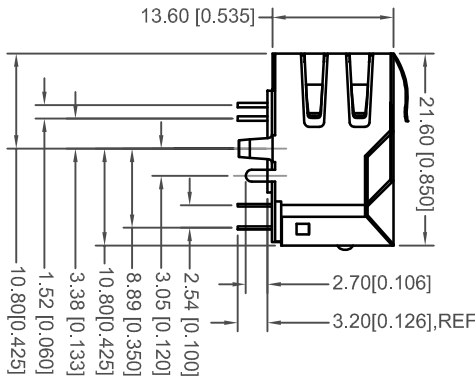
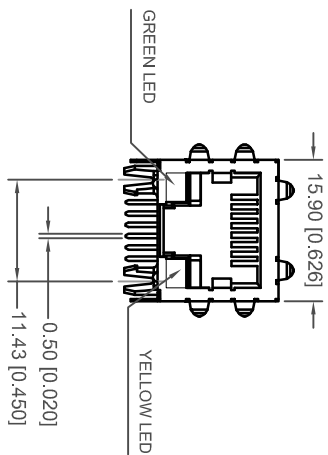

RECOMMENDED P.C.B. LAYOUT
 TOLERANCE: ±0.05[±0.002]

NOTES:
 1. MATERIALS:
 HOUSING: PBT WITH GLASS FIBER, UL94 V-0, COLOR: BLACK
 CONTACTS: 0.35MM PHOSPHOR BRONZE PLATED WITH GOLD PLATING AND TIN IN SOLDER AREA

PART NO GOLD PLATING THICKNESS
 A60-112-300P4D2 GOLD FLASH PLATING
 A60-113-300P4D2 15 MICRO INCHES OF GOLD
 A60-114-300P4D2 30 MICRO INCHES OF GOLD

SHIELD: 0.20MM COPPER ALLOY WITH NICKEL PLATING
 2. OPERATING TEMPERATURE: 0°C TO +70°C
 3. MATE WITH MODULAR PLUG CONFORMING TO FCC PART 68, SUBPART F.
 4. DIMENSION: MM [INCHES]

**RJ45 MAGNETIC JACK WITHOUT LED, 10P, 8C
 SHIELDED/10/100 Mbps FILTER**

ACAD REFERENCE NO.: A60-112-331P4D2

DRAWN: R.STA.MONICA DATE: JAN.26/2011

CHECKED: DATE:

PART NUMBER SHEET 1 OF 2
 SEE NOTE

DRAWING NUMBER ISSUE
 A60-112-331P4D2 1



THIS SERIES FULLY CONFORMS TO THE
 EUROPEAN UNION DIRECTIVES 2002/95/EC
 AND 2002/96/EC FOR ROHS COMPLIANCY.

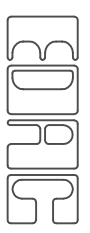

EDAC INC
 TORONTO, ONTARIO
 CANADA

YOUR CONNECTION TO QUALITY & SERVICE

ELECTRICAL CIRCUIT:

TOLERANCE UNLESS OTHERWISE SPECIFIED IN MM:	0	± 0.50	± 0.38	± 0.25	± 0.10
ANGLE	3°				

THIS IS A C.A.D. GENERATED DRAWING
DO NOT MAKE MANUAL REVISIONS TO MASTER.

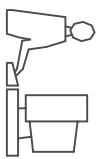

ISSUE NUMBER
ORIGINAL
①

CONNECTOR SOLDER SIDE

RJ45 CONTACT SIDE

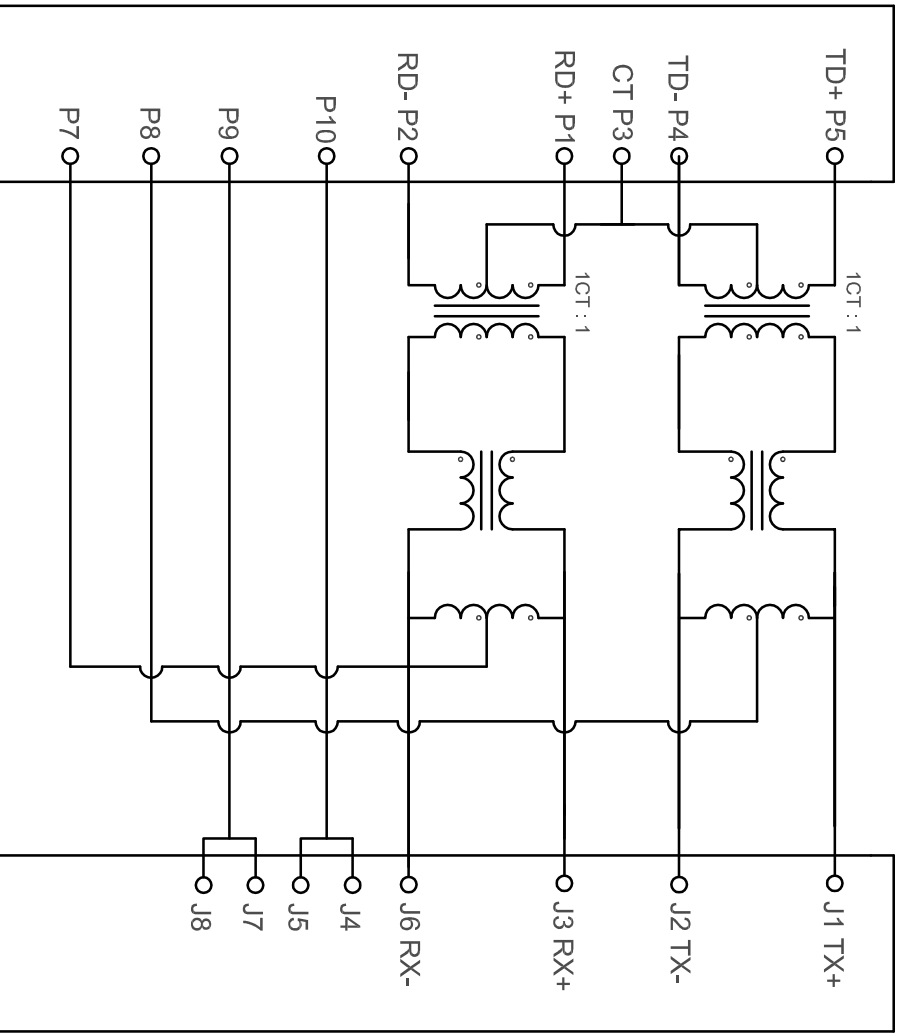

LED CIRCUIT:

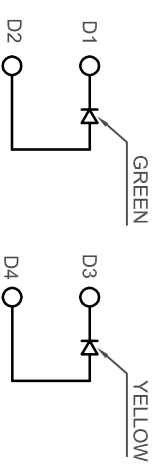

TEST NOTES:(25±5°C)

1. TR:(100KHz,0.1V);
PINS:(P5-P4):(J1-J2)=1:1±3%
PINS:(P1-P2):(J3-J6)=1:1±3%
2. LX:(100KHz,100mV,8mA, DC Bias)
PINS: (P5,P4),(P1,P2)=350uH MINIMUM
- 3.DCR:
PINS:(J1-J2),(J3-J6)= 1.0 OHMS MAXIMUM
- 4.HIPOT:
PINS(P5,P4)TO(J1,J2)=1500VAC FOR 2 SECONDS
PINS(P1,P2)TO(J3,J6)=1500VAC FOR 2 SECONDS
- 5.INSERTION LOSS:
-1.0dB MAXIMUM AT 1MHz TO 100MHz;
- 6.RETURN LOSS:
-18dB MINIMUM AT 1MHz TO 30MHz;
-16dB MINIMUM AT 30MHz TO 60MHz
-12dB MINIMUM AT 60MHz TO 80MHz
- 7.CROSS TALK:
-35dB MINIMUM AT 1MHz TO 100MHz
- 8.COMMON TO COMMON MODE REJECTION:
-30dB MINIMUM AT 1MHz TO 100MHz

Color	Lens Color	Vf(V) @20mA	Iv(mcd) @10mA	Viewing angle
Yellow	Yellow Diffused	Min 1.7 Max 2.8	Min 3.0 Typ 6.0	2θ 116
Green	Green Diffused	1.7	2.8 3.5 6.0	116

**RJ45 MAGNETIC JACK WITHOUT LED, 10P, 8C
SHIELDED/10/100 Mbps FILTER**

ACAD REFERENCE NO.: A60-112-331P4D2

DRAWN: R.STA.MONICA DATE: JAN.26/2011

CHECKED: DATE:

PART NUMBER

SEE NOTE

DRAWING NUMBER SHEET 2 OF 2

A60-112-331P4D2

ISSUE
1



THIS SERIES FULLY CONFORMS TO THE EUROPEAN UNION DIRECTIVES 2002/95/EC AND 2002/96/EC FOR ROHS COMPLIANCY.

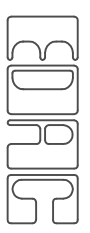

EDAC INC
TORONTO, ONTARIO
CANADA

YOUR CONNECTION TO QUALITY & SERVICE