

TOLERANCE UNLESS OTHERWISE SPECIFIED	
.X	±0.3
.XX	±0.2
.XXX	±0.1

THIS IS A C.A.D. GENERATED DRAWING
DO NOT MAKE MANUAL REVISIONS TO MASTER.

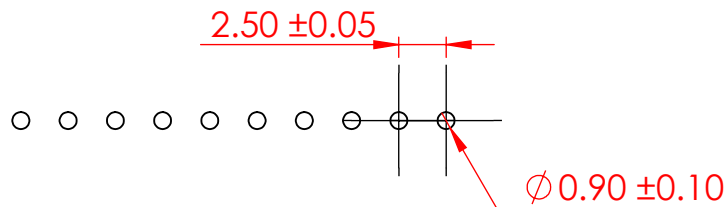

ISSUE NUMBER	
ORIGINAL	①

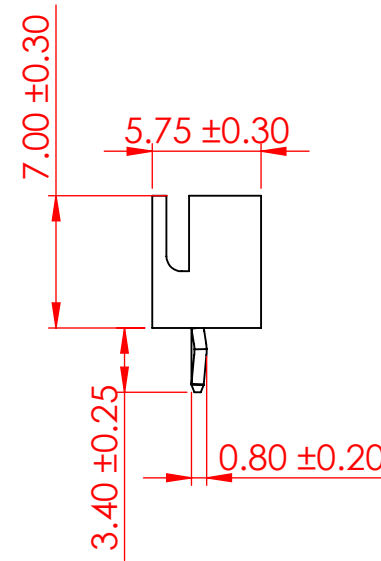
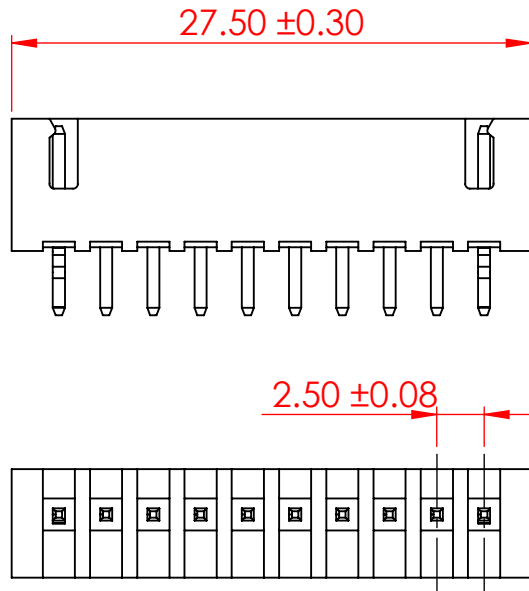

RECOMMENDED PCB LAYOUT

SPECIFICATIONS:
VOLTAGE RATING: 250V AC/DC
CURRENT RATING: 3A AC/DC
WITHSTANDING VOLTAGE: 1000V AC/MIN
TEMPERATURE RANGE: -40°C TO 105°C
INSULATION RESISTANCE: ≥ 1000MΩ
CONTACT RESISTANCE: ≤ 10mΩ

INSULATOR MATERIAL: NYLON 66, UL94V-0
COLOR-NATURAL

CONTACT: BRASS, TIN PLATED

MATES WITH HOUSING: 14K-510-210-AA2

**14K SERIES PIN HEADER, 2.50 PITCH, TOP ENTRY
THROUGH HOLE KINK 2**

ACAD REFERENCE NO.:	14K Assembly	UNIT: MM
DRAWN:	V.K.	DATE: 02/14/24
CHECKED:	R.S.M.	DATE: 02/21/24
SCALE:	2.5:1	SHEET 1 OF 1
DRAWING NUMBER:	14K-510-412-AA1	ISSUE
PART NUMBER:	14K-510-412-AA1	1



THIS SERIES FULLY CONFORMS TO
THE EUROPEAN UNION DIRECTIVES
2011/65/EU FOR RoHS COMPLIANCY.



EDAC INC
TORONTO, ONTARIO
CANADA
YOUR CONNECTION TO QUALITY & SERVICE

THESE DRAWINGS AND SPECIFICATIONS
ARE THE PROPERTY OF EDAC INC., AND
SHALL NOT BE REPRODUCED, OR COPIED
OR USED AS THE BASIS FOR THE
MANUFACTURE OR SALE OF APPARATUS
WITHOUT WRITTEN PERMISSION.