

TOLERANCE UNLESS OTHERWISE SPECIFIED	
.X	±0.3
.XX	±0.2
.XXX	±0.1

THIS IS A C.A.D. GENERATED DRAWING  
DO NOT MAKE MANUAL REVISIONS TO MASTER.

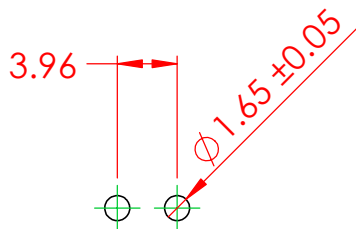

ISSUE NUMBER	
ORIGINAL	①
TEMP RANGE UPDATED V.K.	APR. 10/2024 ②

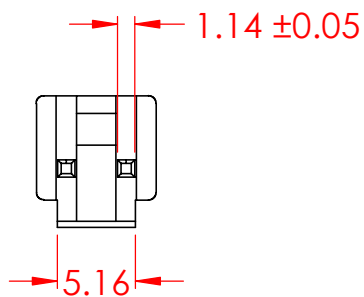
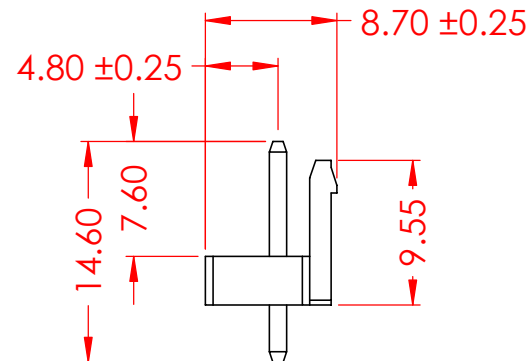
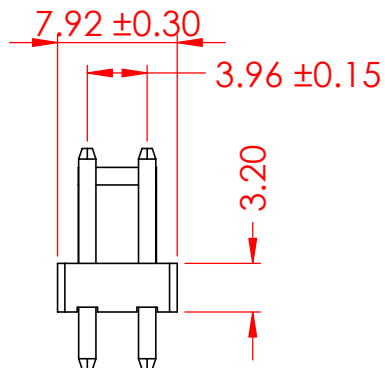

RECOMMEND PCB LAYOUT

**SPECIFICATIONS**

VOLTAGE RATING: 250V AC/DC  
 CURRENT RATING: 7A AC/DC  
 WITHSTANDING VOLTAGE: 1500VAC/MIN  
 TEMPERATURE RANGE: -40 °C TO 105 °C  
 INSULATION RESISTANCE: 1000MΩ MIN  
 CONTACT RESISTANCE: 10mΩ MAX

INSULATOR MATERIAL: NYLON 66, UL94V-0  
 COLOR - NATURAL

CONTACT: BRASS, GOLD FLASH

MATES WITH HOUSING: 14L-602-210-AA2



THIS SERIES FULLY CONFORMS TO  
THE EUROPEAN UNION DIRECTIVES  
2011/65/EU FOR RoHS COMPLIANCY.



EDAC INC  
TORONTO, ONTARIO  
CANADA  
YOUR CONNECTION TO QUALITY & SERVICE

THESE DRAWINGS AND SPECIFICATIONS  
ARE THE PROPERTY OF EDAC INC., AND  
SHALL NOT BE REPRODUCED, OR COPIED  
OR USED AS THE BASIS FOR THE  
MANUFACTURE OR SALE OF APPARATUS  
WITHOUT WRITTEN PERMISSION.

14L SERIES PIN HEADER, 3.96 PITCH, TOP ENTRY	ACAD REFERENCE NO.: 14L Assembly	UNIT: MM
	DRAWN: V.K.	DATE: 11/21/23
	CHECKED: R.S.M	DATE: 11/21/23
	SCALE: 2:1	SHEET 1 OF 1
	DRAWING NUMBER: 14L-602-215-AA1	ISSUE
	PART NUMBER: 14L-602-215-AA1	2