

TOLERANCE UNLESS OTHERWISE SPECIFIED	
.X	±0.3
.XX	±0.2
.XXX	±0.1

THIS IS A C.A.D. GENERATED DRAWING  
DO NOT MAKE MANUAL REVISIONS TO MASTER.

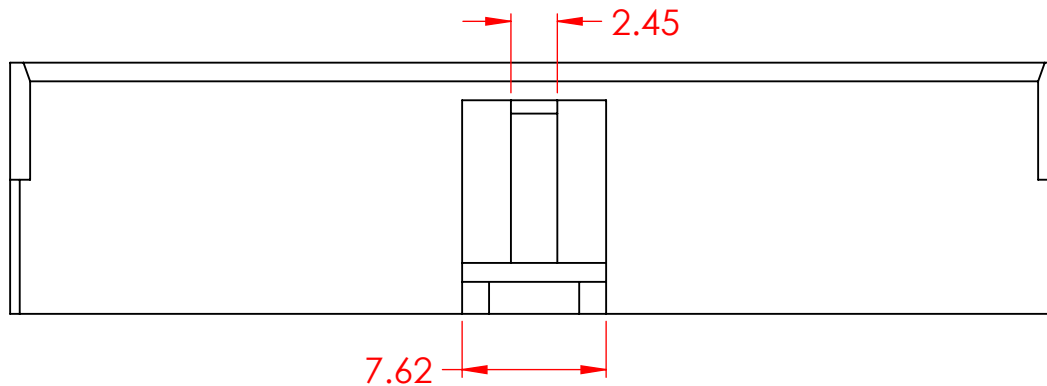

ISSUE NUMBER	
ORIGINAL	①
TEMP RANGE UPDATED V.K. APR. 10/2024	②

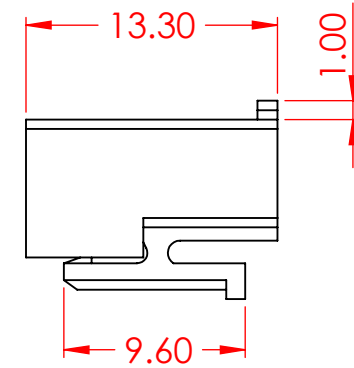
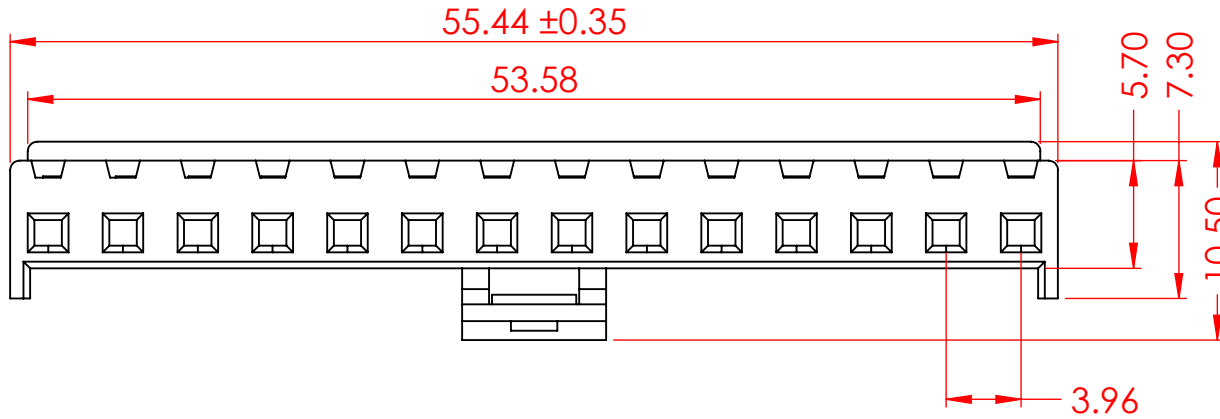

**SPECIFICATIONS**

VOLTAGE RATING: 250V AC/DC  
 CURRENT RATING: 7A AC/DC  
 WITHSTANDING VOLTAGE: 1500V AC/MIN  
 TEMPERATURE RANGE: -25°C TO 105°C  
 INSULATION RESISTANCE: ≥ 1000MΩ  
 CONTACT RESISTANCE: ≤ 10mΩ

MATERIAL: NYLON 66, UL94V-0  
 COLOR: NATURAL

USE CONTACT: 14L-292-482 (TIN PLATED)  
 MATES WITH PIN HEADER  
 TOP ENTRY - 14L-614-415-AA1  
 SIDE ENTRY - 14L-614-416-AA1

USE CONTACT: 14L-292-282 (GOLD FLASH)  
 MATES WITH PIN HEADER  
 TOP ENTRY - 14L-614-215-AA1  
 SIDE ENTRY - 14L-614-216-AA1

<b>14L SERIES 3.96MM PITCH SINGLE ROW HOUSING</b>	ACAD REFERENCE NO.: 14L Assembly	UNIT: MM
	DRAWN: V.K.	DATE: 11/16/23
	CHECKED: R.S.M	DATE: 11/21/23
	SCALE: 2:1	SHEET 1 OF 1
	DRAWING NUMBER: 14L-614-210-AA2	ISSUE
	PART NUMBER: 14L-614-210-AA2	2



THIS SERIES FULLY CONFORMS TO  
THE EUROPEAN UNION DIRECTIVES  
2011/65/EU FOR RoHS COMPLIANCY.



EDAC INC  
TORONTO, ONTARIO  
CANADA  
YOUR CONNECTION TO QUALITY & SERVICE

THESE DRAWINGS AND SPECIFICATIONS  
ARE THE PROPERTY OF EDAC INC., AND  
SHALL NOT BE REPRODUCED, OR COPIED  
OR USED AS THE BASIS FOR THE  
MANUFACTURE OR SALE OF APPARATUS  
WITHOUT WRITTEN PERMISSION.