

TOLERANCE UNLESS OTHERWISE SPECIFIED	
0-10	±0.20
10-30	±0.30
30-100	±0.40

THIS IS A C.A.D. GENERATED DRAWING  
DO NOT MAKE MANUAL REVISIONS TO MASTER.

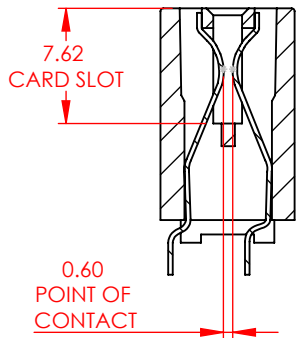

ISSUE NUMBER	
ORIGINAL	①
REMOVE CODE 99 J.L.	MAR.22/2024 ②

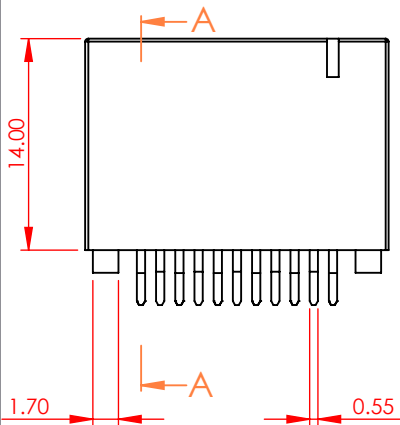
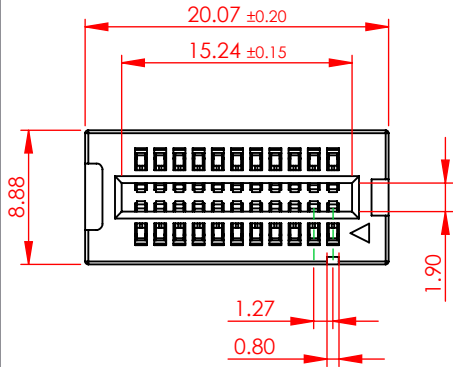

SECTION A-A

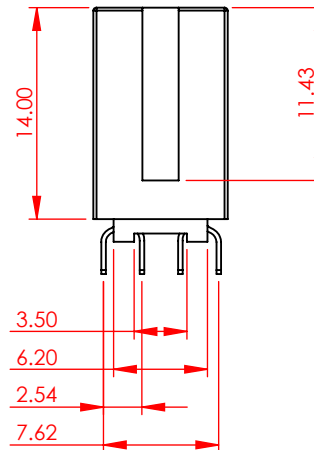

**SPECIFICATIONS:**

**MATERIAL:** GLASS REINFORCED THERMOPLASTIC, PA66  
**CONTACT:** COPPER ALLOY  
**PLATING:** 15µ" GOLD PLATING ON CONTACT AREA, TIN PLATING ON SOLDERING AREA

**ELECTRICAL**  
**VOLTAGE RATING:** 250 VAC RMS  
**CURRENT RATING:** 1A  
**DIELECTRIC**  
**WITHSTANDING VOLTAGE:** 500VAC RMS 60Hz FOR 60s  
**INSULATION RESISTANCE:** 1000 MEGA OHMS MIN AT 500VDC  
**CONTACT RESISTANCE:** 30 mOHMS MAX

**MECHANICAL**  
**RETENTION FORCE:** 460g MIN PER CONTACT  
**INSERTION FORCE:** 230g MAX PER CONTACT PAIR  
**WITHDRAWAL FORCE:** 15g MIN PER CONTACT PAIR

**ENVIRONMENTAL**  
**TEMPERATURE RANGE:** -55°C TO +85°C



THIS SERIES FULLY CONFORMS TO THE EUROPEAN UNION DIRECTIVES 2011/65/EU FOR RoHS COMPLIANCY.



EDAC INC  
TORONTO, ONTARIO  
CANADA  
YOUR CONNECTION TO QUALITY & SERVICE

THESE DRAWINGS AND SPECIFICATIONS ARE THE PROPERTY OF EDAC INC., AND SHALL NOT BE REPRODUCED, OR COPIED OR USED AS THE BASIS FOR THE MANUFACTURE OR SALE OF APPARATUS WITHOUT WRITTEN PERMISSION.

302 SERIES CARD EDGE CONNECTOR

ACAD REFERENCE NO.:	302 Assembly	UNIT: MM
DRAWN:	J.L.	DATE: 06/06/23
CHECKED:	R.S.M.	DATE: 04/09/24
SCALE:	2:1	SHEET 1 OF 2
DRAWING NUMBER:	302-022-321-201	ISSUE
PART NUMBER:	302-022-321-201	2



NO. OF POS.	DIMENSION A	
	CONTACT CODE 21	CONTACT CODE 58
04	1.27	
06	2.54	
08	3.81	
10	5.08	
12	6.35	
14	7.62	
16	8.89	
20	11.43	
22	12.70	
24	13.97	
26	15.24	
30	17.78	
32	19.05	
36	21.59	
40	24.13	
48	29.21	
50	30.48	
52	31.75	
60	36.83	
68	41.91	NA
70	43.18	NA
80	49.53	
100	62.23	NA
110	68.58	NA
120	74.93	NA
124	77.47	NA

NA = NOT AVAILABLE

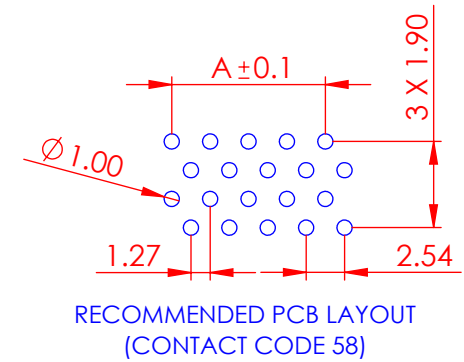
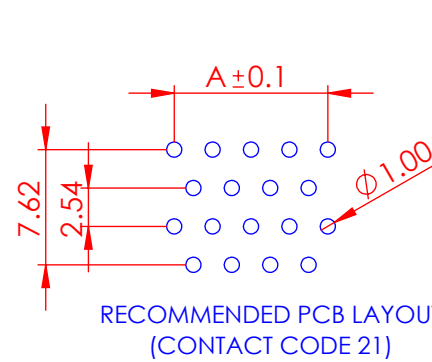

302-022-321-201

└─ MOUNTING CODE

└─ CONTACT CODE



THIS SERIES FULLY CONFORMS TO  
THE EUROPEAN UNION DIRECTIVES  
2011/65/EU FOR RoHS COMPLIANCY.



YOUR CONNECTION TO QUALITY & SERVICE

EDAC INC  
TORONTO, ONTARIO  
CANADA

THESE DRAWINGS AND SPECIFICATIONS  
ARE THE PROPERTY OF EDAC INC., AND  
SHALL NOT BE REPRODUCED, OR COPIED  
OR USED AS THE BASIS FOR THE  
MANUFACTURE OR SALE OF APPARATUS  
WITHOUT WRITTEN PERMISSION.

### 302 SERIES CARD EDGE CONNECTOR

ACAD REFERENCE NO.:	302 Assembly	UNIT: MM
DRAWN:	J.L.	DATE: 06/06/23
CHECKED:	R.S.M.	DATE: 04/11/24
SCALE:	N.T.S	SHEET 2 OF 2
DRAWING NUMBER:	302-022-321-201	ISSUE
PART NUMBER:	302-022-321-201	2