

TOLERANCE UNLESS OTHERWISE SPECIFIED	
0-10	±0.20
10-30	±0.30
30-100	±0.40

THIS IS A C.A.D. GENERATED DRAWING  
DO NOT MAKE MANUAL REVISIONS TO MASTER.

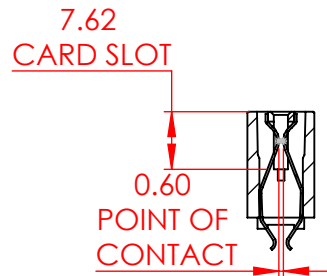

ISSUE NUMBER	
ORIGINAL	①
UPDATE PAGE 2 AVAILABILITY J.L.	APR.11/2024 ②

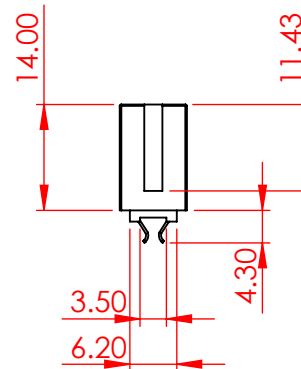
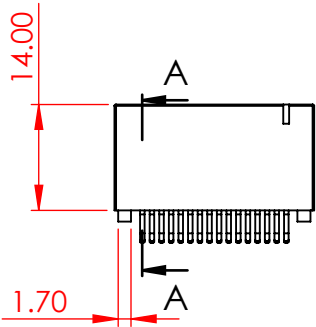
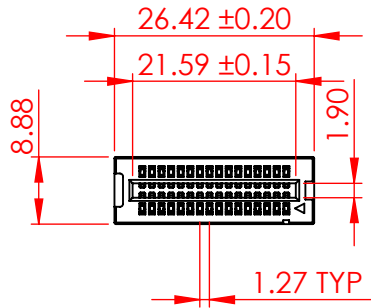

SECTION A-A

**SPECIFICATIONS:**

**MATERIAL:** GLASS REINFORCED THERMOPLASTIC, PA66  
**CONTACT:** COPPER ALLOY  
**PLATING:** GOLD FLASH PLATING ON CONTACT AREA, TIN PLATING ON SOLDERING AREA

**ELECTRICAL**  
**VOLTAGE RATING:** 250 VAC RMS  
**CURRENT RATING:** 1A  
**DIELECTRIC**  
**WITHSTANDING VOLTAGE:** 500VAC RMS 60Hz FOR 60s  
**INSULATION RESISTANCE:** 1000 MEGA OHMS MIN AT 500VDC  
**CONTACT RESISTANCE:** 30 mOHMS MAX

**MECHANICAL**  
**RETENTION FORCE:** 460g MIN PER CONTACT  
**INSERTION FORCE:** 230g MAX PER CONTACT PAIR  
**WITHDRAWAL FORCE:** 15g MIN PER CONTACT PAIR

**ENVIRONMENTAL**  
**TEMPERATURE RANGE:** -55°C TO +85°C



THIS SERIES FULLY CONFORMS TO THE EUROPEAN UNION DIRECTIVES 2011/65/EU FOR RoHS COMPLIANCY.



YOUR CONNECTION TO QUALITY & SERVICE

EDAC INC  
TORONTO, ONTARIO  
CANADA

THESE DRAWINGS AND SPECIFICATIONS ARE THE PROPERTY OF EDAC INC., AND SHALL NOT BE REPRODUCED, OR COPIED OR USED AS THE BASIS FOR THE MANUFACTURE OR SALE OF APPARATUS WITHOUT WRITTEN PERMISSION.

302 SERIES CARD EDGE CONNECTOR		ACAD REFERENCE NO.:	302 Assembly	UNIT:	MM
DRAWN:	J.L.	DATE:	06/06/23		
CHECKED:	R.S.M.	DATE:	04/09/24		
SCALE:	1:1	SHEET	1	OF	2
DRAWING NUMBER:	302-032-256-201	ISSUE			
PART NUMBER:	302-032-256-201	ISSUE	2		

THIS IS A C.A.D. GENERATED DRAWING  
DO NOT MAKE MANUAL REVISIONS TO MASTER.



ISSUE NUMBER

SEE PAGE 1

NO. OF POS.	CONTACT CODE 56
04	AVAILABLE
06	AVAILABLE
08	AVAILABLE
10	AVAILABLE
12	AVAILABLE
14	AVAILABLE
16	AVAILABLE
20	AVAILABLE
22	AVAILABLE
24	AVAILABLE
26	AVAILABLE
30	AVAILABLE
32	AVAILABLE
36	AVAILABLE
40	AVAILABLE
48	AVAILABLE
50	AVAILABLE
52	AVAILABLE
60	AVAILABLE
68	AVAILABLE
70	AVAILABLE
80	AVAILABLE
100	AVAILABLE
110	AVAILABLE
120	AVAILABLE
124	AVAILABLE

302-032-256-201



302 SERIES CARD EDGE CONNECTOR

ACAD REFERENCE NO.: 302 Assembly UNIT: MM

DRAWN: J.L. DATE: 06/06/23

CHECKED: R.S.M. DATE: 04/09/24

SCALE: 3:2 SHEET 2 OF 2

DRAWING NUMBER: 302-032-256-201 ISSUE

PART NUMBER: 302-032-256-201 2



THIS SERIES FULLY CONFORMS TO  
THE EUROPEAN UNION DIRECTIVES  
2011/65/EU FOR RoHS COMPLIANCY.



YOUR CONNECTION TO QUALITY & SERVICE

EDAC INC  
TORONTO, ONTARIO  
CANADA

THESE DRAWINGS AND SPECIFICATIONS  
ARE THE PROPERTY OF EDAC INC., AND  
SHALL NOT BE REPRODUCED, OR COPIED  
OR USED AS THE BASIS FOR THE  
MANUFACTURE OR SALE OF APPARATUS  
WITHOUT WRITTEN PERMISSION.