

TOLERANCE UNLESS OTHERWISE SPECIFIED	
0-10	±0.20
10-30	±0.30
30-100	±0.40

THIS IS A C.A.D. GENERATED DRAWING
DO NOT MAKE MANUAL REVISIONS TO MASTER.

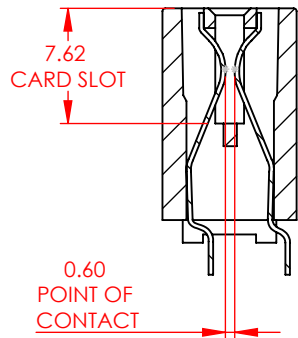

ISSUE NUMBER	
ORIGINAL	①
REMOVE CODE 99 J.L.	MAR.22/2024 ②

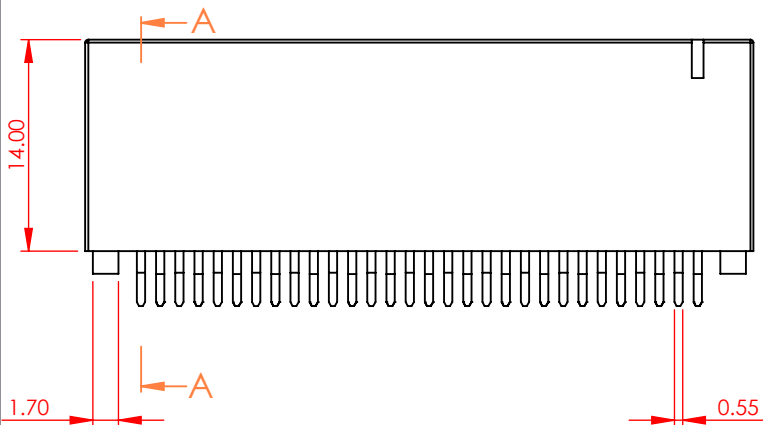
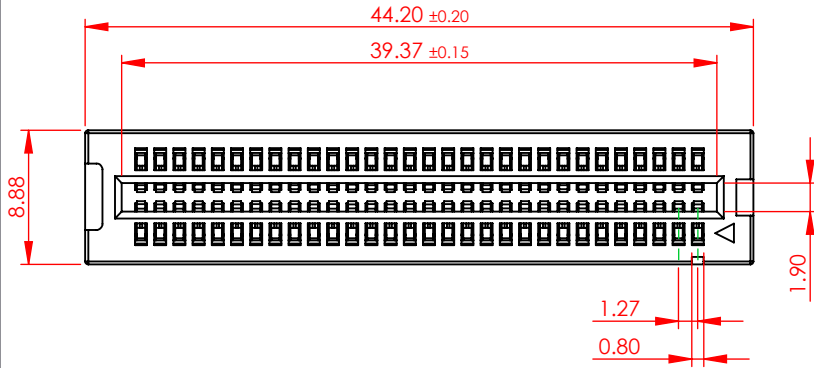

SECTION A-A

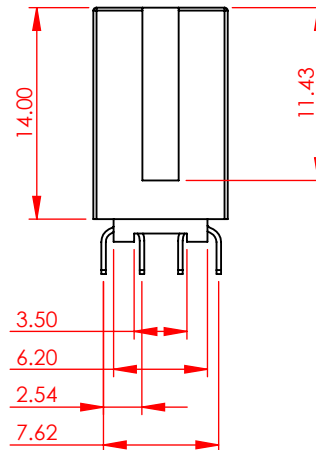

SPECIFICATIONS:

MATERIAL:

GLASS REINFORCED
THERMOPLASTIC, PA66

CONTACT:

COPPER ALLOY

PLATING:

15µ" GOLD PLATING ON CONTACT
AREA, TIN PLATING ON
SOLDERING AREA

ELECTRICAL

VOLTAGE RATING:

250 VAC RMS

CURRENT RATING:

1A

DIELECTRIC

WITHSTANDING VOLTAGE: 500VAC RMS 60Hz FOR 60s

INSULATION RESISTANCE:

1000 MEGA OHMS MIN AT 500VDC

CONTACT RESISTANCE:

30 mOHMS MAX

MECHANICAL

RETENTION FORCE:

460g MIN PER CONTACT

INSERTION FORCE:

230g MAX PER CONTACT PAIR

WITHDRAWAL FORCE:

15g MIN PER CONTACT PAIR

ENVIRONMENTAL

TEMPERATURE RANGE:

-55°C TO +85°C



THIS SERIES FULLY CONFORMS TO
THE EUROPEAN UNION DIRECTIVES
2011/65/EU FOR RoHS COMPLIANCY.



EDAC INC
TORONTO, ONTARIO
CANADA

YOUR CONNECTION TO QUALITY & SERVICE

THESE DRAWINGS AND SPECIFICATIONS
ARE THE PROPERTY OF EDAC INC., AND
SHALL NOT BE REPRODUCED, OR COPIED
OR USED AS THE BASIS FOR THE
MANUFACTURE OR SALE OF APPARATUS
WITHOUT WRITTEN PERMISSION.

302 SERIES CARD EDGE CONNECTOR

ACAD REFERENCE NO.:	302 Assembly	UNIT: MM
DRAWN:	J.L.	DATE: 06/06/23
CHECKED:	R.S.M.	DATE: 04/09/24
SCALE:	2:1	SHEET 1 OF 2
DRAWING NUMBER:	302-060-321-201	ISSUE
PART NUMBER:	302-060-321-201	2



NO. OF POS.	DIMENSION A	
	CONTACT CODE 21	CONTACT CODE 58
04	1.27	
06	2.54	
08	3.81	
10	5.08	
12	6.35	
14	7.62	
16	8.89	
20	11.43	
22	12.70	
24	13.97	
26	15.24	
30	17.78	
32	19.05	
36	21.59	
40	24.13	
48	29.21	
50	30.48	
52	31.75	
60	36.83	
68	41.91	NA
70	43.18	NA
80	49.53	
100	62.23	NA
110	68.58	NA
120	74.93	NA
124	77.47	NA

NA = NOT AVAILABLE

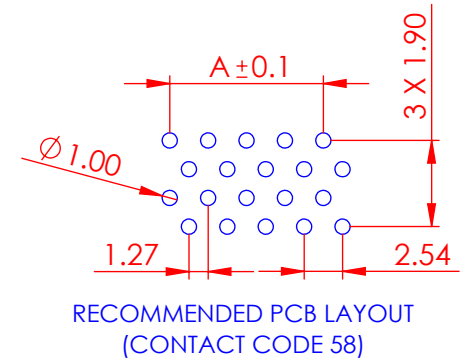
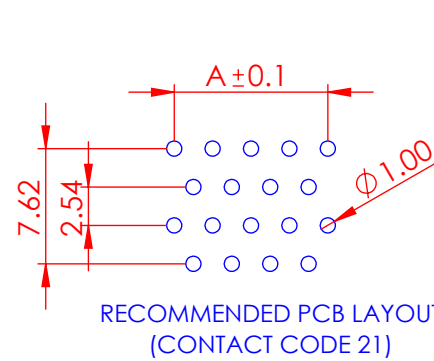

302-060-321-201

└─ MOUNTING CODE

└─ CONTACT CODE



THIS SERIES FULLY CONFORMS TO
THE EUROPEAN UNION DIRECTIVES
2011/65/EU FOR RoHS COMPLIANCY.



YOUR CONNECTION TO QUALITY & SERVICE

EDAC INC
TORONTO, ONTARIO
CANADA

THESE DRAWINGS AND SPECIFICATIONS
ARE THE PROPERTY OF EDAC INC., AND
SHALL NOT BE REPRODUCED, OR COPIED
OR USED AS THE BASIS FOR THE
MANUFACTURE OR SALE OF APPARATUS
WITHOUT WRITTEN PERMISSION.

302 SERIES CARD EDGE CONNECTOR

ACAD REFERENCE NO.:	302 Assembly	UNIT: MM
DRAWN:	J.L.	DATE: 06/06/23
CHECKED:	R.S.M.	DATE: 04/11/24
SCALE:	N.T.S	SHEET 2 OF 2
DRAWING NUMBER:	302-060-321-201	ISSUE
PART NUMBER:	302-060-321-201	2