

NOTES:

- INSULATOR MATERIAL - POLYPHENYLENE SULPHIDE, UL 94V-0
- CONTACT MATERIAL - PHOSPHOR BRONZE ALLOY
- CONTACT PLATING - GOLD OVER NICKEL UNDERPLATE
- MOUNTING OPTION - 03-.116 (2.95) I.D. Floating Eyelets
- CONTACT TYPE - 543-Wire Wrap .045 Sq.(1.14 Sq.) - Tail LG=.900(22.86)

TOLERANCE UNLESS OTHERWISE SPECIFIED	
.XX	±.01
.XXX	±.005
.XXXX	±.0005

THIS IS A C.A.D. GENERATED DRAWING
DO NOT MAKE MANUAL REVISIONS TO MASTER.



ISSUE NUMBER	
ORIGINAL	①

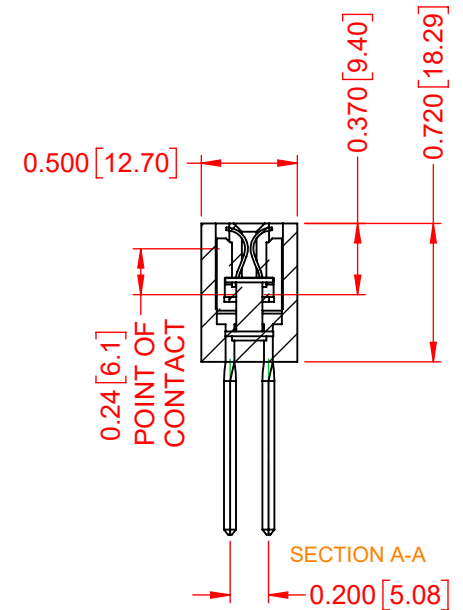
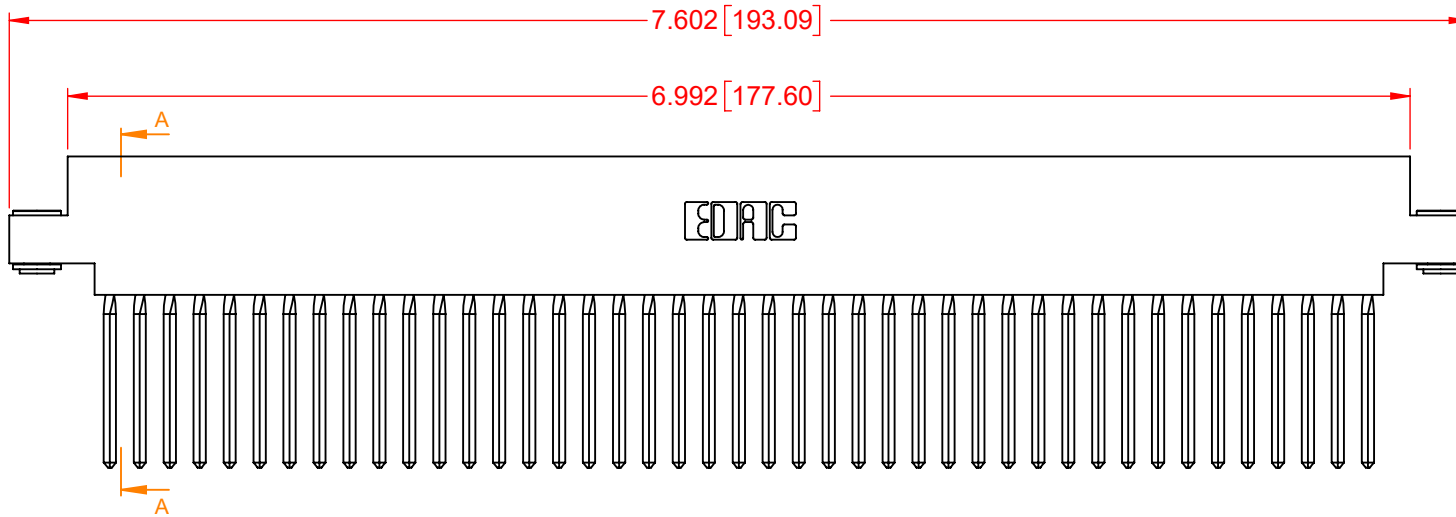
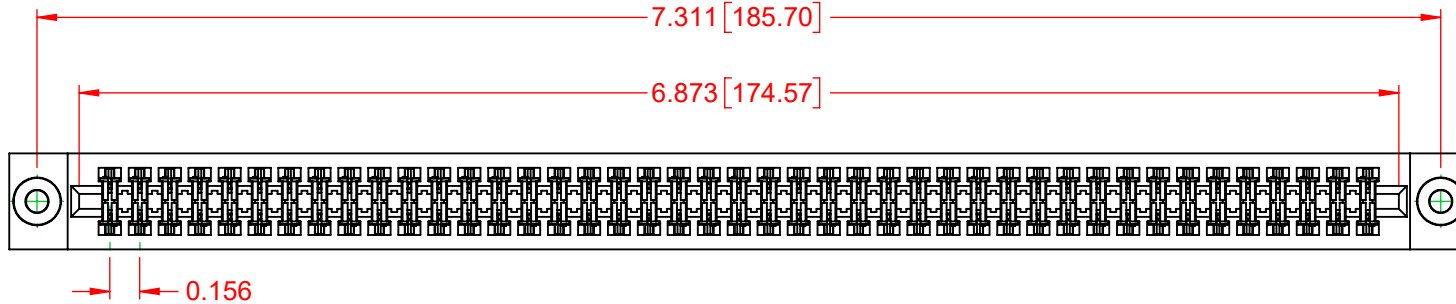

317 SERIES CARD EDGE CONNECTOR

ACAD REFERENCE NO.: 317 Assembly	
DRAWN: C.B	DATE: February 5, 2020
CHECKED:	DATE:
SCALE: 1:1	SHEET 1 OF 1
DRAWING NUMBER: 317-086-543-803	ISSUE
PART NUMBER: 317-086-543-803	1



THIS SERIES FULLY CONFORMS TO
THE EUROPEAN UNION DIRECTIVES
2011/65/EU FOR RoHS COMPLIANCY.



YOUR CONNECTION TO QUALITY & SERVICE

EDAC INC
TORONTO, ONTARIO
CANADA

THESE DRAWINGS AND SPECIFICATIONS
ARE THE PROPERTY OF EDAC INC., AND
SHALL NOT BE REPRODUCED, OR COPIED
OR USED AS THE BASIS FOR THE
MANUFACTURE OR SALE OF APPARATUS
WITHOUT WRITTEN PERMISSION.