

THIS IS A C.A.D. GENERATED DRAWING
DO NOT MAKE MANUAL REVISIONS TO MASTER.

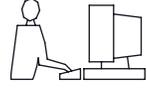

ISSUE NUMBER	
ORIGINAL	①

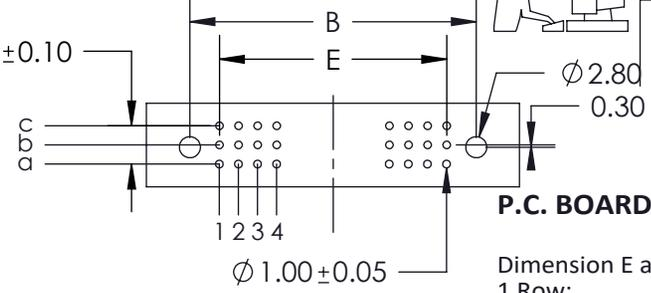
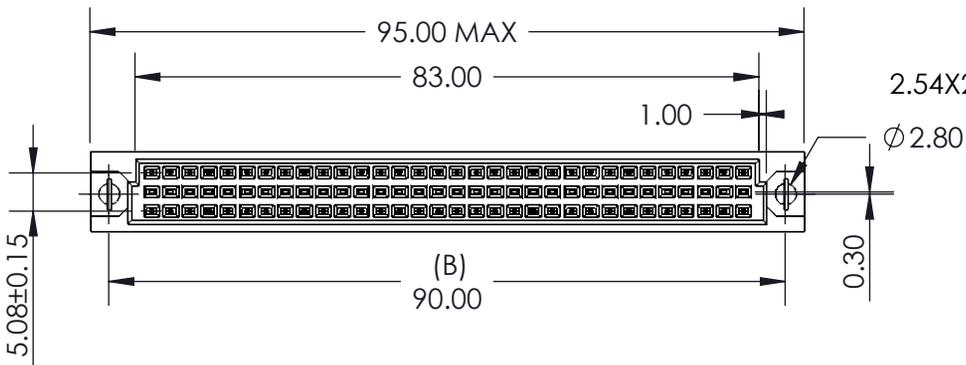

P.C. BOARD PATTERN

Dimension E at 2.54 Pitch:
 1 Row:
 E= No. of Positions-1 X 2.54
 2 Rows:
 E= (No. of Positions/2)-1 X 2.54
 3 Rows:
 E= (No. of Positions/3)-1 X 2.54

Two Prong Board Lock (optional)

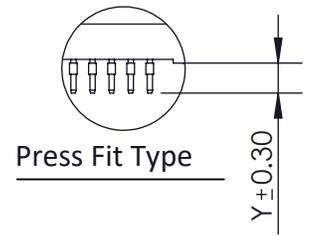
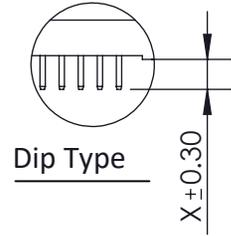
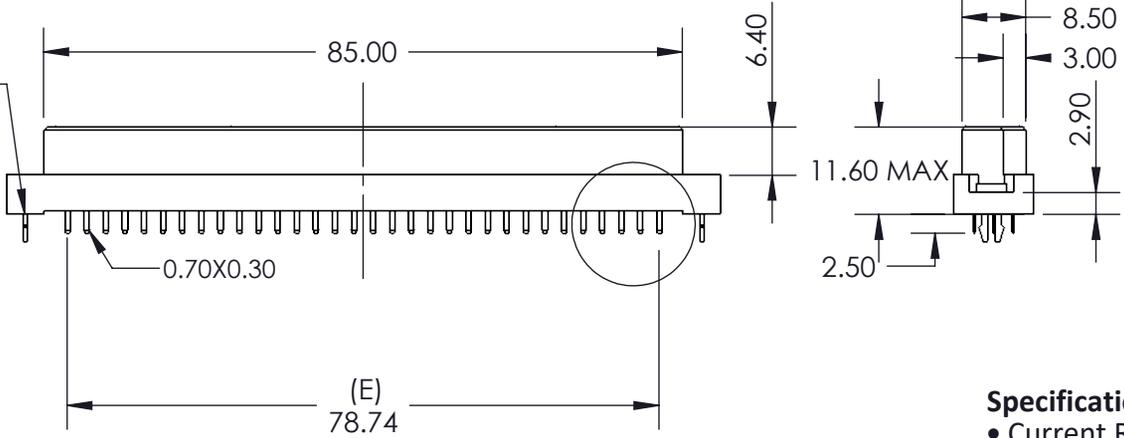

Features:

- High density 96 Contacts 3 Row Metal-to-Metal Connector on 2.54mm (.100") Grid
- Contacts: Straight
- Contact Material: Phosphor Bronze with selective gold plating: 2-Gold Flash Plating and tin on tails
- Contact Tails: 0.7 x 0.3mm (.028" x .012") Rectangular
- Contact Spacing: 2.54 x 2.54mm (.100" x .100") single, double or triple rows; or 2.54 x 5.08mm (.100" x .200") single, double or triple rows.
- Available in: 8, 16, 24, 32, 48, 64, and 96 positions
- Connectors designed to meet DIN 41612 specifications

Specifications:

- Current Rating: 2 Amperes @ 20°C
- Contact Material: Copper Alloy
- Contact Plating: Selective Gold Plating
- Contact Resistance: 30 milliohms, maximum
- Insulator Material: 30% Glass Filled PBT, UL 94V-0
- Insulation Resistance: 1000 Mega (10⁶) ohms MIN at DC500V
- Dielectric Withstanding Voltage: 1000 VAC FOR 1 MINUTE
- Basic Grid: 2.54mm (.100")
- Operating Temperature: -55°C to +125°C

496 Series Metal-To-Metal Receptacle DIN Connector
 PART NUMBER: 496-196-222-313

ACAD REFERENCE NO.	496 -ENG-MASTER
DRAWN:R.STA.MONICA	DATE: AUG.12/10
CHECKED:	DATE:
SCALE: NTS	SHEET 1 OF 1
DRAWING NUMBER	ISSUE
496 -ENG-MASTER	1

EDAC INC
 TORONTO, ONTARIO
 CANADA
 YOUR CONNECTION TO QUALITY & SERVICE

THESE DRAWINGS AND SPECIFICATIONS ARE THE PROPERTY OF EDAC INC. AND SHALL NOT BE REPRODUCED, OR COPIED OR USED AS THE BASIS FOR THE MANUFACTURE OR SALE OF APPARATUS WITHOUT WRITTEN PERMISSION.



THIS SERIES FULLY CONFORMS TO THE EUROPEAN UNION DIRECTIVES 2002/95/EC AND 2002/96/EC FOR RoHS COMPLIANCY