

TOLERANCE UNLESS OTHERWISE SPECIFIED IN MM:  
GENERAL ±0.02 [0.5]

THIS IS A C.A.D. GENERATED DRAWING  
DO NOT MAKE MANUAL REVISIONS TO MASTER.

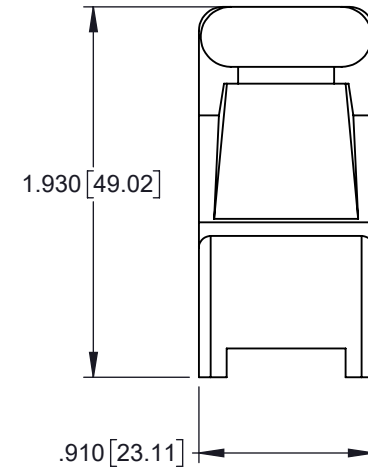

ISSUE NUMBER	
ORIGINAL	①
ADD TOL J.T	MAY10/17 ②

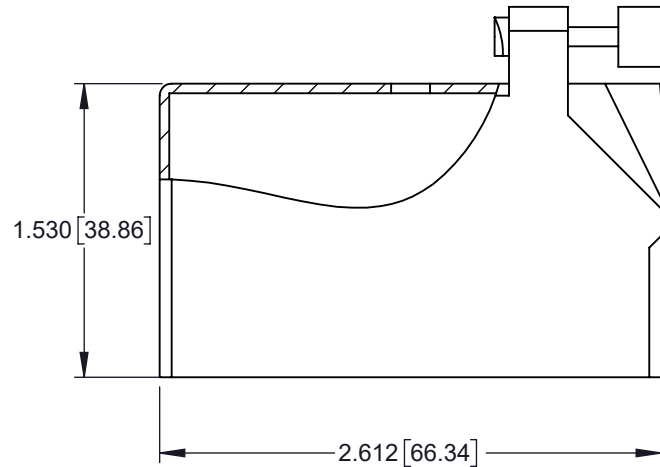
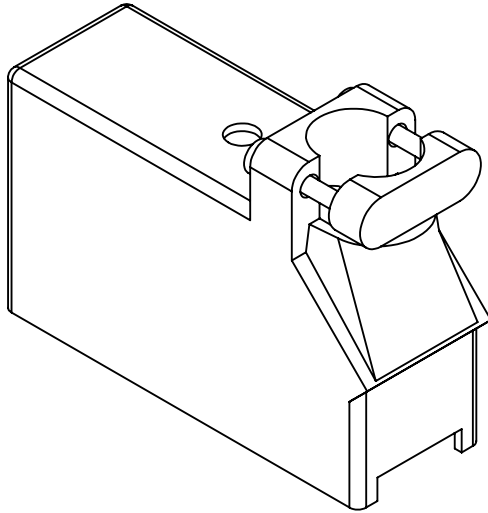

**ORDERING CODE:**

**516-230-156**

Series: \_\_\_\_\_

Cover Sub-Assembly: \_\_\_\_\_

Entry Style:  
1-Plastic Cover, Top Entry, Standard Clamp

Cover Size: SIZE 56 \_\_\_\_\_

MATERIAL:  
POLYCARBONATE, GREEN IN COLOR.



THIS SERIES FULLY CONFORMS TO THE EUROPEAN UNION DIRECTIVES 2011/65/EC RoHS COMPLIANCY.



YOUR CONNECTION TO QUALITY & SERVICE

EDAC INC  
TORONTO, ONTARIO  
CANADA

THESE DRAWINGS AND SPECIFICATIONS ARE THE PROPERTY OF EDAC INC. AND SHALL NOT BE REPRODUCED, OR COPIED OR USED AS THE BASIS FOR THE MANUFACTURE OR SALE OF APPARATUS WITHOUT WRITTEN PERMISSION.

**516 SERIES COVER ASSEMBLY  
PART NUMBER: 516-230-156**

ACAD REFERENCE NO. 516-230-156	
DRAWN: R.STA.MONICA	DATE: MAY.27/11
CHECKED:	DATE:
SCALE: NOT TO SCALE	SHEET 1 1
DRAWING NUMBER <b>516-230-156</b>	ISSUE 2