

TOLERANCE UNLESS OTHERWISE SPECIFIED IN MM:
GENERAL ±0.02 [0.5]

THIS IS A C.A.D. GENERATED DRAWING
DO NOT MAKE MANUAL REVISIONS TO MASTER.

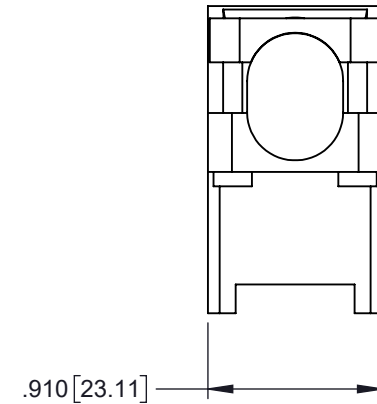

ISSUE NUMBER	
ORIGINAL	①
ADD TOL J.T	MAY10/17 ②

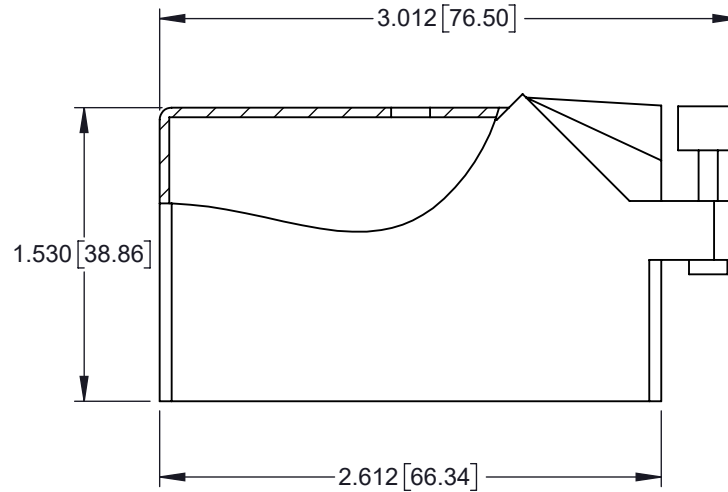
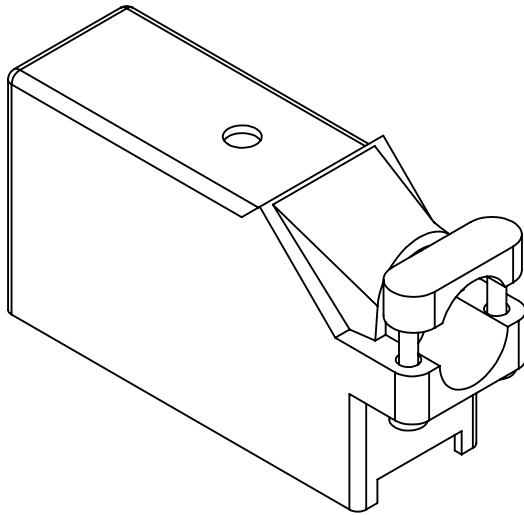

ORDERING CODE:

516-230-256

Series: _____

Cover Sub-Assembly: _____

Entry Style:
2-Plastic Cover, Side Entry, Standard Clamp

Cover Size: SIZE 56 _____

MATERIAL:
POLYCARBONATE, GREEN IN COLOR.



THIS SERIES FULLY CONFORMS TO THE
EUROPEAN UNION DIRECTIVES 2011/65/EC
RoHS COMPLIANCY.

**516 SERIES COVER ASSEMBLY
PART NUMBER: 516-230-256**



YOUR CONNECTION TO QUALITY & SERVICE

EDAC INC
TORONTO, ONTARIO
CANADA

THESE DRAWINGS AND SPECIFICATIONS
ARE THE PROPERTY OF EDAC INC. AND
SHALL NOT BE REPRODUCED, OR COPIED
OR USED AS THE BASIS FOR THE
MANUFACTURE OR SALE OF APPARATUS
WITHOUT WRITTEN PERMISSION.

ACAD REFERENCE NO. 516-230-256	
DRAWN: R.STA.MONICA	DATE: MAY.27/11
CHECKED:	DATE:
SCALE: NOT TO SCALE	SHEET 1 1
DRAWING NUMBER 516-230-256	ISSUE 2