

TOLERANCE UNLESS OTHERWISE SPECIFIED	
.X	±0.25
.XX	±0.13
.XXX	±0.10

THIS IS A C.A.D. GENERATED DRAWING
DO NOT MAKE MANUAL REVISIONS TO MASTER.

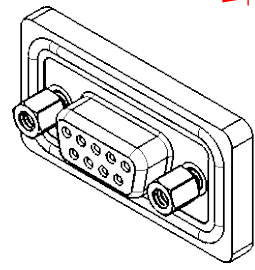

ISSUE NUMBER	
ORIGINAL	①
PANEL CUT-OUT ADDED 03/2024	②

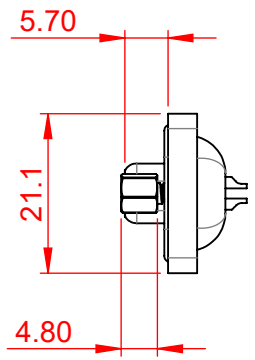

RECOMMENDED PANEL CUT-OUT

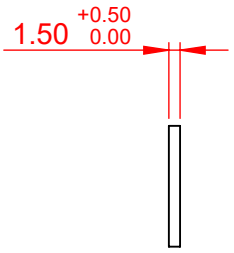
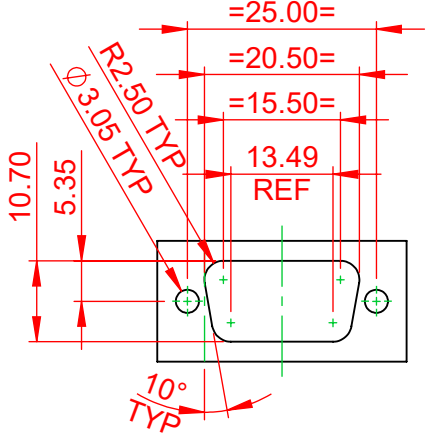

PANEL THICKNESS

NOTES:

- MATERIAL:** THERMOPLASTIC POLYESTER, UL94V-0
- HOUSING:** STEEL, NICKEL PLATED
- SHELL:** COPPER ALLOY, GOLD FLASH PLATED
- CONTACT:** COPPER ALLOY, GOLD FLASH PLATED
- OPERATING TEMPERATURE:** -25°C TO 85°C
- CURRENT RATING:** 5A PER CONTACT
- CONTACT RESISTANCE:** 25mΩ MAX.
- INSULATOR RESISTANCE:** 5000MΩ min.
- DIELECTRIC WITHSTANDING VOLTAGE:** 1000V AC rms

DIM' TOLERANCE = ±0.05



THIS SERIES FULLY CONFORMS TO THE EUROPEAN UNION DIRECTIVES 2011/65/EU FOR RoHS COMPLIANCY.

EDAC EDAC INC
TORONTO, ONTARIO
CANADA
YOUR CONNECTION TO QUALITY & SERVICE

THESE DRAWINGS AND SPECIFICATIONS ARE THE PROPERTY OF EDAC INC., AND SHALL NOT BE REPRODUCED, OR COPIED OR USED AS THE BASIS FOR THE MANUFACTURE OR SALE OF APPARATUS WITHOUT WRITTEN PERMISSION.

628 SERIES D-SUB CONNECTOR		SW REFERENCE NO.: 628M ASSEMBLY	
DRAWN: C.B		DATE: AUG. 01/2018	
CHECKED:		DATE:	
SCALE: 1:1		SHEET 1 OF 1	
DRAWING NUMBER: 628-W09-322-012			ISSUE
PART NUMBER: 628-W09-322-012			2