

TOLERANCE UNLESS OTHERWISE SPECIFIED	
.X	±0.25
.XX	±0.13
.XXX	±0.10

THIS IS A C.A.D. GENERATED DRAWING
DO NOT MAKE MANUAL REVISIONS TO MASTER.



ISSUE NUMBER	
ORIGINAL	①
PANEL CUT-OUT ADDED APRIL 2024	②

RECOMMENDED PANEL CUT-OUT

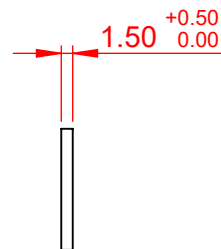
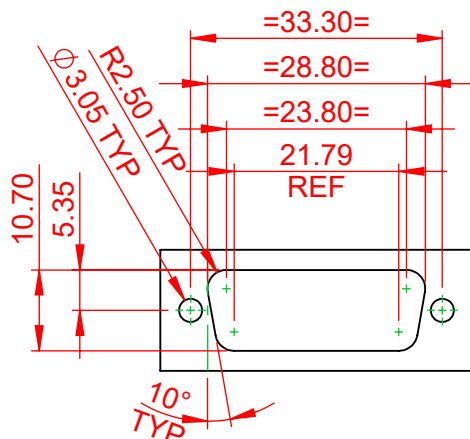

PANEL THICKNESS

NOTES:

MATERIAL: PBT, UL94V-0
 HOUSING: STEEL, NICKEL PLATED
 SHELL: STEEL, NICKEL PLATED
 CONTACT: COPPER ALLOY, 15µ GOLD PLATED
 O-RING: SILICONE

OPERATING TEMPERATURE: -25°C TO +85°C

CURRENT RATING: 3A PER CONTACT
 CONTACT RESISTANCE: 10mΩ MAX.
 INSULATOR RESISTANCE: 5000MΩ min.
 DIELECTRIC WITHSTANDING VOLTAGE: 1000V AC rms

DIM' TOLERANCE = ±0.05



THIS SERIES FULLY CONFORMS TO THE EUROPEAN UNION DIRECTIVES 2011/65/EU FOR RoHS COMPLIANCY.



YOUR CONNECTION TO QUALITY & SERVICE

EDAC INC
TORONTO, ONTARIO
CANADA

THESE DRAWINGS AND SPECIFICATIONS ARE THE PROPERTY OF EDAC INC., AND SHALL NOT BE REPRODUCED, OR COPIED OR USED AS THE BASIS FOR THE MANUFACTURE OR SALE OF APPARATUS WITHOUT WRITTEN PERMISSION.

638W SERIES D-SUB CONNECTOR		SW REFERENCE NO.:	638W ASSEMBLY
DRAWN:	C.B	DATE:	AUG. 01/2018
CHECKED:		DATE:	
SCALE:	1:1	SHEET	1 OF 1
DRAWING NUMBER:	638-W26-321-012	ISSUE	
PART NUMBER:	638-W26-321-012		2