

TOLERANCE UNLESS OTHERWISE SPECIFIED	
.X	±0.25
.XX	±0.13
.XXX	±0.05

THIS IS A C.A.D. GENERATED DRAWING
DO NOT MAKE MANUAL REVISIONS TO MASTER.

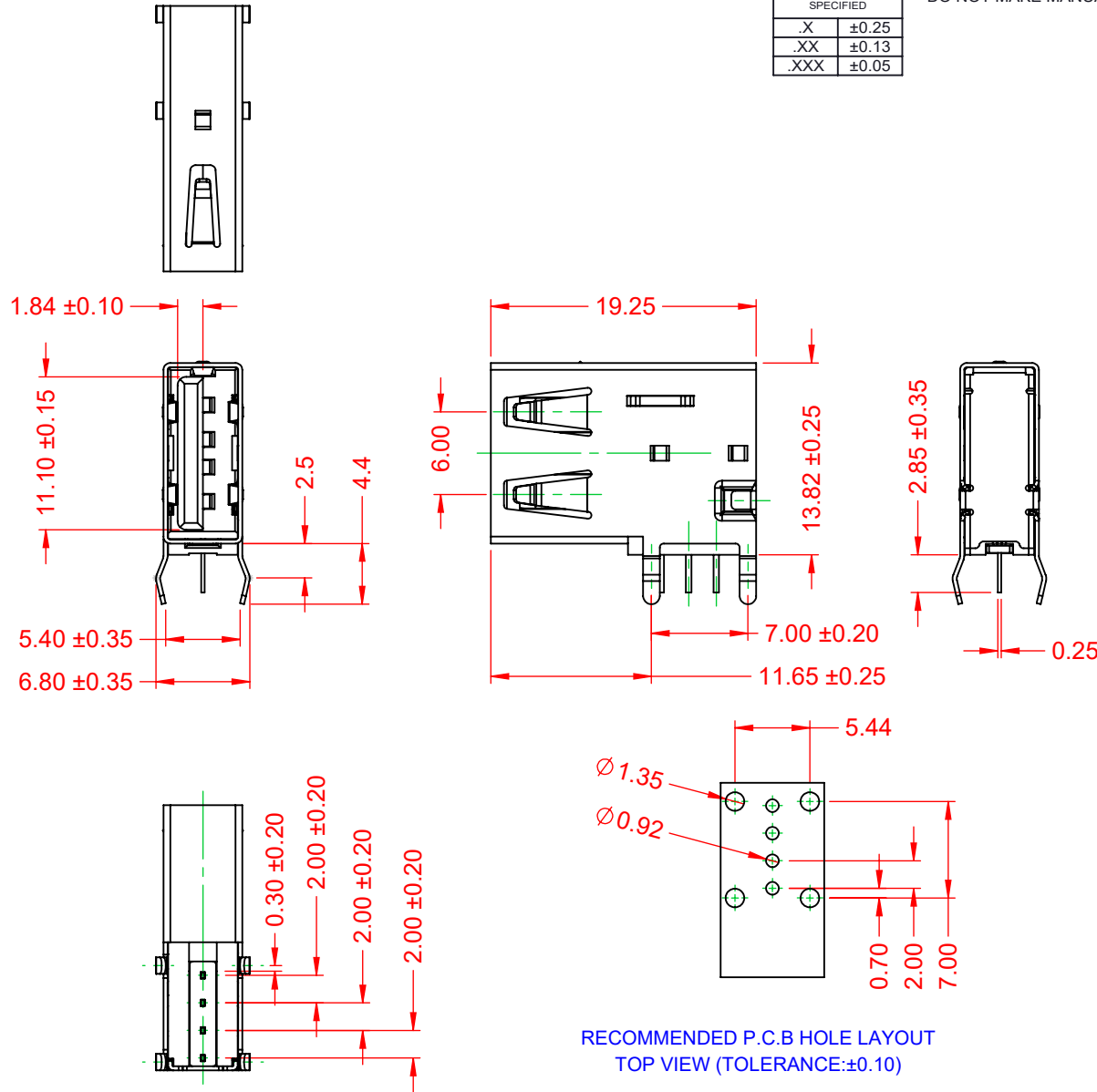

ISSUE NUMBER
ORIGINAL ①

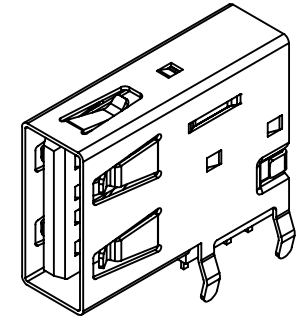

NOTE:
ELECTRICAL SPECIFICATIONS:
 VOLTAGE RATING: 30V MAX.
 CURRENT RATING: 1.5A per CONTACT
 CONTACT RESISTANCE: 30mΩ MAX.
 INSULATOR RESISTANCE: 1000MΩ min.
 DIELECTRIC WITHSTANDING VOLTAGE: 500V AC
 OPERATING TEMPERATURE: -20°C ~ 60°C

MATERIAL & FINISH:
 SHELL: T=0.30, PLATING NICKEL/TIN
 HOUSING: PBT, BLACK IN COLOUR, UL94V-0
 CONTACTS: 15µ" GOLD PLATING

RECOMMENDED P.C.B HOLE LAYOUT
TOP VIEW (TOLERANCE:±0.10)



THIS SERIES FULLY CONFORMS TO
THE EUROPEAN UNION DIRECTIVES
2011/65/EU FOR RoHS COMPLIANCY.



YOUR CONNECTION TO QUALITY & SERVICE

EDAC INC
TORONTO, ONTARIO
CANADA

THESE DRAWINGS AND SPECIFICATIONS
ARE THE PROPERTY OF EDAC INC., AND
SHALL NOT BE REPRODUCED, OR COPIED
OR USED AS THE BASIS FOR THE
MANUFACTURE OR SALE OF APPARATUS
WITHOUT WRITTEN PERMISSION.

690 SERIES RECEPTACLES USB 2.0
TYPE-A UPRIGHT R/ANGLE PCB

ACAD REFERENCE NO.: 690C104-X34-22X	
DRAWN: C.B	DATE: December 15, 2020
CHECKED:	DATE:
SCALE: 2:1	SHEET 1 OF 1
DRAWING NUMBER: 690C104-X34-22X	ISSUE
PART NUMBER: 690C104-534-221	1