

TOLERANCE UNLESS OTHERWISE SPECIFIED	
.X	±0.25
.XX	±0.13
.XXX	±0.05

THIS IS A C.A.D. GENERATED DRAWING
DO NOT MAKE MANUAL REVISIONS TO MASTER.

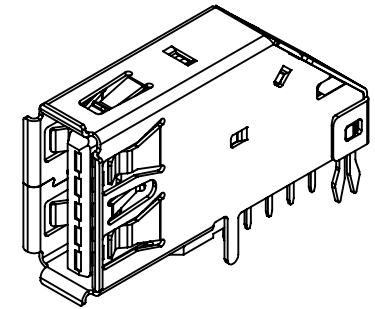

ISSUE NUMBER	
ORIGINAL	①



NOTE:

ELECTRICAL SPECIFICATIONS: 30V MAX.
VOLTAGE RATING: 1.8A per CONTACT
CURRENT RATING: 30mΩ MAX. INITIAL FOR
CONTACT RESISTANCE: VBUS AND GND CONTACTS
 50mΩ MAX. INITIAL FOR ALL
 OTHER CONTACTS

INSULATOR RESISTANCE: 100MΩ min.
**DIELECTRIC WITHSTANDING
 VOLTAGE:** 100V AC
OPERATING TEMPERATURE: -40°C ~ 85°C
STORAGE TEMPERATURE: -20°C ~ 60°C

MATERIAL & FINISH:

SHELL: STAINLESS STEEL, T=0.30,
 NICKEL PLATING
HOUSING: PBT, BLACK IN COLOUR, UL94V-0
CONTACTS: COPPER ALLOY, T=0.20,
 TIN PLATING ON SOLDER TAILS,
 15μ" GOLD PLATING
 ON CONTACT AREA



THIS SERIES FULLY CONFORMS TO
THE EUROPEAN UNION DIRECTIVES
2011/65/EU FOR RoHS COMPLIANCY.



YOUR CONNECTION TO QUALITY & SERVICE

EDAC INC
TORONTO, ONTARIO
CANADA

THESE DRAWINGS AND SPECIFICATIONS
ARE THE PROPERTY OF EDAC INC., AND
SHALL NOT BE REPRODUCED, OR COPIED
OR USED AS THE BASIS FOR THE
MANUFACTURE OR SALE OF APPARATUS
WITHOUT WRITTEN PERMISSION.

**690 SERIES RECEPTACLES USB 3.0
TYPE-A UPRIGHT R/ANGLE PCB**

ACAD REFERENCE NO.: 690D109-X39-0XX	
DRAWN: C.B	DATE: December 17, 2020
CHECKED:	DATE:
SCALE: 2:1	SHEET 1 OF 2
DRAWING NUMBER: 690D109-X39-0XX	ISSUE
PART NUMBER: 690D109-539-021	1

TOLERANCE UNLESS OTHERWISE SPECIFIED	
.X	±0.25
.XX	±0.13
.XXX	±0.05

THIS IS A C.A.D. GENERATED DRAWING
DO NOT MAKE MANUAL REVISIONS TO MASTER.



ISSUE NUMBER	
ORIGINAL	①

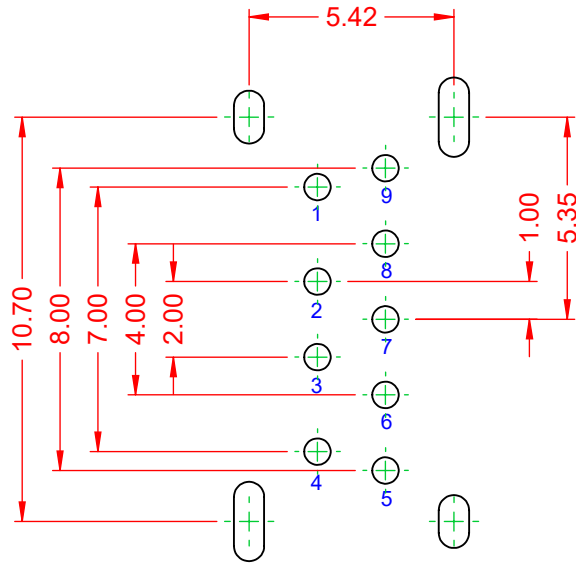

⊕0.10Ⓢ XⓈ YⓈ

RECOMMENDED PCB LAYOUT (COMPONENT TOP VIEW)
THK=1.60 ALL TOL IS ±0.10

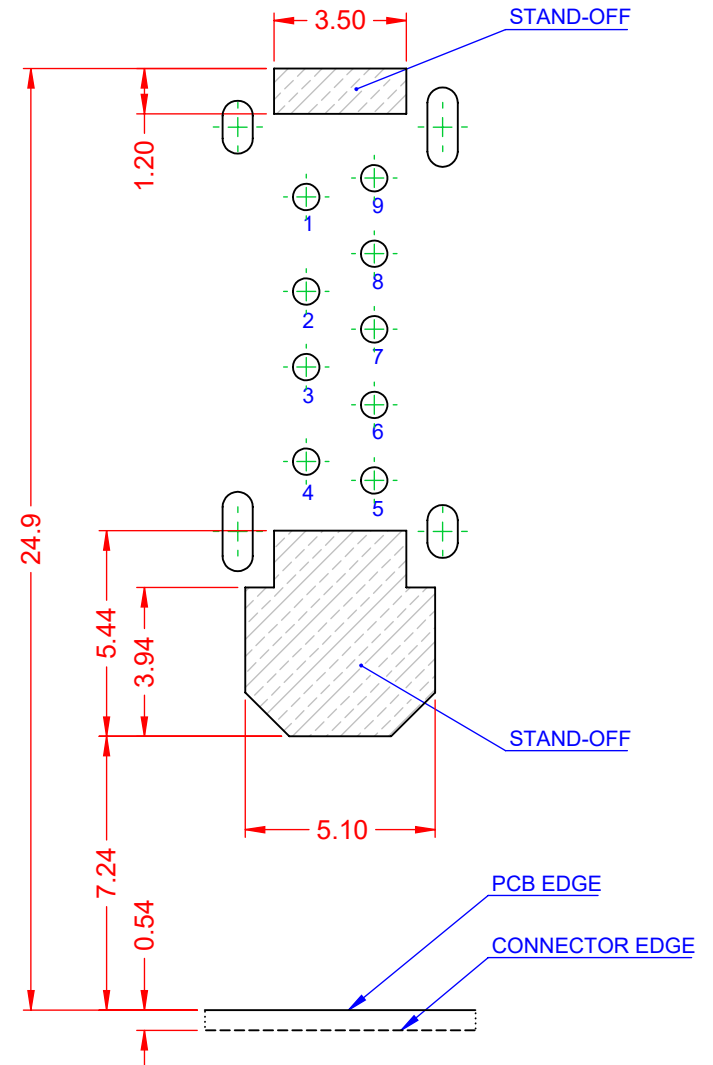

690 SERIES RECEPTACLES USB 3.0
TYPE-A UPRIGHT R/ANGLE PCB

ACAD REFERENCE NO.: 690D109-X39-0XX	
DRAWN: C.B	DATE: December 17, 2020
CHECKED:	DATE:
SCALE: 5:1	SHEET 2 OF 2
DRAWING NUMBER: 690D109-X39-0XX	ISSUE
PART NUMBER: 690D109-539-021	1



THIS SERIES FULLY CONFORMS TO
THE EUROPEAN UNION DIRECTIVES
2011/65/EU FOR RoHS COMPLIANCY.



EDAC INC
TORONTO, ONTARIO
CANADA
YOUR CONNECTION TO QUALITY & SERVICE

THESE DRAWINGS AND SPECIFICATIONS
ARE THE PROPERTY OF EDAC INC., AND
SHALL NOT BE REPRODUCED, OR COPIED
OR USED AS THE BASIS FOR THE
MANUFACTURE OR SALE OF APPARATUS
WITHOUT WRITTEN PERMISSION.