

THIS IS A C.A.D. GENERATED DRAWING
DO NOT MAKE MANUAL REVISIONS TO MASTER.

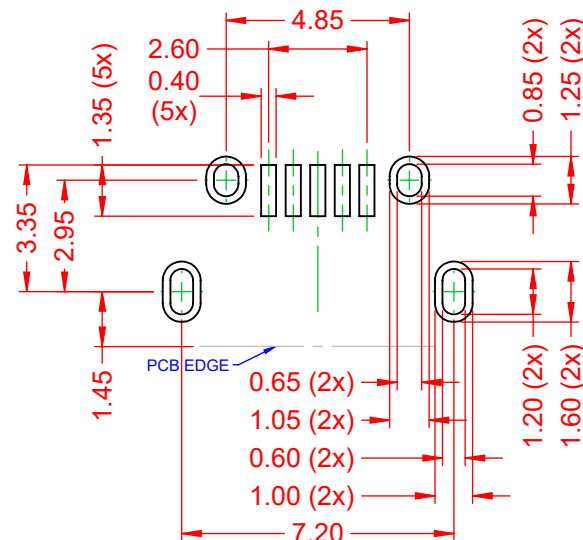

TOLERANCE UNLESS OTHERWISE SPECIFIED	
.X	±0.25
.XX	±0.20
.XXX	±0.10
.XXXX	±0.05

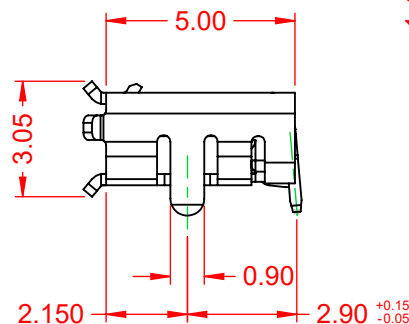
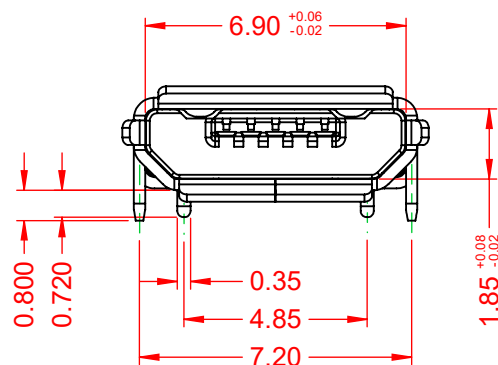
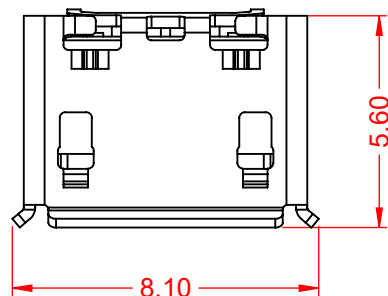

RECOMMENDED P.C.B HOLE LAYOUT
TOP VIEW - TOL' = ±0.05

NOTE:

ELECTRICAL SPECIFICATIONS:

- VOLTAGE RATING: 30V MAX.
- CURRENT RATING: 1.8A
- CONTACT RESISTANCE: 30mΩ MAX.
- INSULATOR RESISTANCE: 1000MΩ min.
- DIELECTRIC WITHSTANDING VOLTAGE: 100V AC
- OPERATING TEMPERATURE: -20°C ~ 85°C

MATERIAL & FINISH:

- SHELL: STAINLESS STEEL, NICKEL PLATED
- HOUSING: LCP, WHITE IN COLOUR, UL94V-0
- CONTACTS: COPPER ALLOY, 6μ" GOLD PLATED

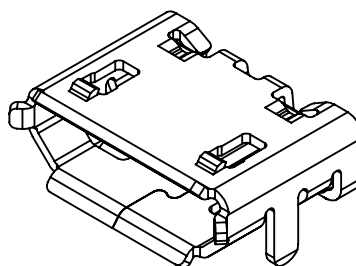
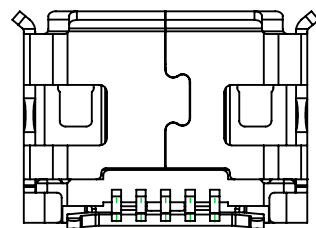

690 SERIES MICRO-USB RECEPTACLE

ACAD REFERENCE NO.: 690T505-X62-01X	
DRAWN: C.B	DATE: December 23, 2020
CHECKED:	DATE:
SCALE: 5:1	SHEET 1 OF 1
DRAWING NUMBER: 690T505-X62-01X	ISSUE
PART NUMBER: 690T505-362-010	1



THIS SERIES FULLY CONFORMS TO
THE EUROPEAN UNION DIRECTIVES
2011/65/EU FOR RoHS COMPLIANCY.



EDAC INC
TORONTO, ONTARIO
CANADA
YOUR CONNECTION TO QUALITY & SERVICE

THESE DRAWINGS AND SPECIFICATIONS
ARE THE PROPERTY OF EDAC INC., AND
SHALL NOT BE REPRODUCED, OR COPIED
OR USED AS THE BASIS FOR THE
MANUFACTURE OR SALE OF APPARATUS
WITHOUT WRITTEN PERMISSION.