

TOLERANCE UNLESS OTHERWISE SPECIFIED	
.X	±0.25
.XX	±0.13
.XXX	±0.05

THIS IS A C.A.D. GENERATED DRAWING
DO NOT MAKE MANUAL REVISIONS TO MASTER.

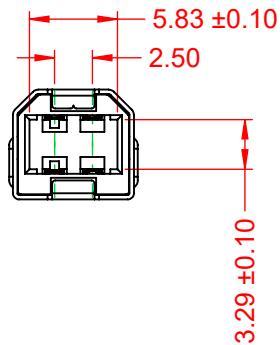

ISSUE NUMBER	
ORIGINAL	①

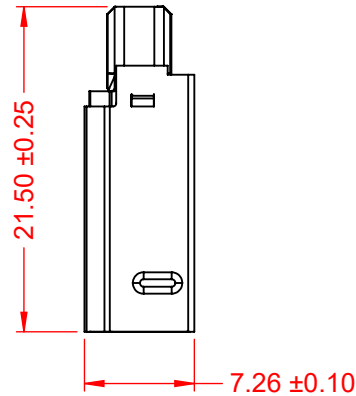
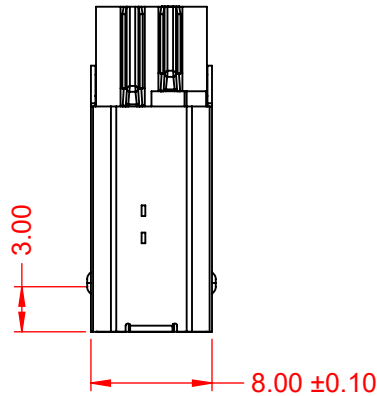
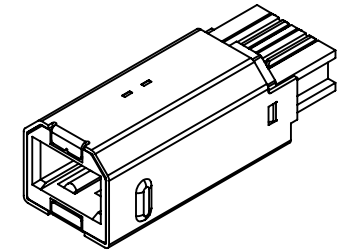
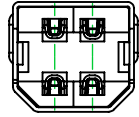

NOTE:

ELECTRICAL SPECIFICATIONS:

VOLTAGE RATING: 30V MAX.
 CURRENT RATING: 1.5A
 CONTACT RESISTANCE: 30mΩ MAX.
 INSULATOR RESISTANCE: 1000MΩ min.
 DIELECTRIC WITHSTANDING
 VOLTAGE: 500V AC
 OPERATING TEMPERATURE: -20°C ~ 60°C

MATERIAL & FINISH:

SHELL: STAINLESS STEEL, T=0.30, NICKEL PLATING
 HOUSING: PBT, WHITE IN COLOUR, UL94V-0
 CONTACTS: COPPER ALLOY, T=0.20, 6μ" GOLD PLATING

690 SERIES PLUGS USB TYPE-B CABLE END

ACAD REFERENCE NO.: 691F204-X90-12X	
DRAWN: C.B	DATE: December 19, 2020
CHECKED:	DATE:
SCALE: 2:1	SHEET 1 OF 1
DRAWING NUMBER: 691F204-X90-12X	ISSUE
PART NUMBER: 691F204-390-120	1



THIS SERIES FULLY CONFORMS TO
THE EUROPEAN UNION DIRECTIVES
2011/65/EU FOR RoHS COMPLIANCY.



EDAC INC
TORONTO, ONTARIO
CANADA
YOUR CONNECTION TO QUALITY & SERVICE

THESE DRAWINGS AND SPECIFICATIONS
ARE THE PROPERTY OF EDAC INC., AND
SHALL NOT BE REPRODUCED, OR COPIED
OR USED AS THE BASIS FOR THE
MANUFACTURE OR SALE OF APPARATUS
WITHOUT WRITTEN PERMISSION.