

TOLERANCE UNLESS OTHERWISE SPECIFIED	
.X	±0.25
.XX	±0.13
.XXX	±0.05

THIS IS A C.A.D. GENERATED DRAWING  
DO NOT MAKE MANUAL REVISIONS TO MASTER.

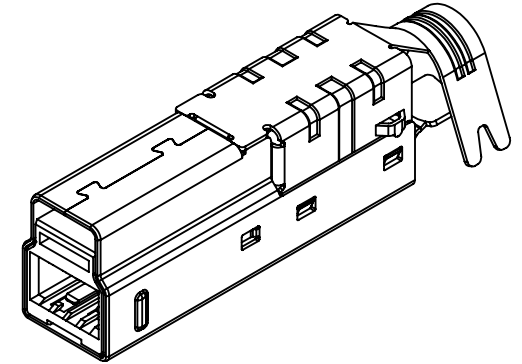

ISSUE NUMBER	
ORIGINAL	①



**NOTE:**  
**ELECTRICAL SPECIFICATIONS:**  
**VOLTAGE RATING:** 30V MAX.  
**CURRENT RATING:** 1.8A PER PIN 1 & PIN 4  
0.25A FOR OTHER CONTACTS  
**CONTACT RESISTANCE:** 30mΩ MAX. FOR PIN 1 & PIN 4  
50mΩ MAX FOR OTHER CONTACTS  
**INSULATOR RESISTANCE:** 100MΩ min.  
**DIELECTRIC WITHSTANDING VOLTAGE:** 100V AC  
**OPERATING TEMPERATURE:** -20°C ~ 85°C

**MATERIAL & FINISH:**  
**SHELL:** STAINLESS STEEL, NICKEL PLATING  
**HOUSING:** LCP, BLACK IN COLOUR, UL94V-0  
**CONTACTS:** COPPER ALLOY, T=0.25  
30µ" GOLD PLATED



THIS SERIES FULLY CONFORMS TO  
THE EUROPEAN UNION DIRECTIVES  
2011/65/EU FOR RoHS COMPLIANCY.



YOUR CONNECTION TO QUALITY & SERVICE

EDAC INC  
TORONTO, ONTARIO  
CANADA

THESE DRAWINGS AND SPECIFICATIONS  
ARE THE PROPERTY OF EDAC INC., AND  
SHALL NOT BE REPRODUCED, OR COPIED  
OR USED AS THE BASIS FOR THE  
MANUFACTURE OR SALE OF APPARATUS  
WITHOUT WRITTEN PERMISSION.

### 690 SERIES PLUGS USB TYPE-B CABLE END

ACAD REFERENCE NO.: 691F209-X90-7XX	
DRAWN: C.B	DATE: December 19, 2020
CHECKED:	DATE:
SCALE: 2:1	SHEET 1 OF 1
DRAWING NUMBER: 691F209-X90-7XX	ISSUE
PART NUMBER: 691F209-690-711	1