

TOLERANCE UNLESS OTHERWISE SPECIFIED	
.X	±0.25
.XX	±0.13
.XXX	±0.05

THIS IS A C.A.D. GENERATED DRAWING
DO NOT MAKE MANUAL REVISIONS TO MASTER.

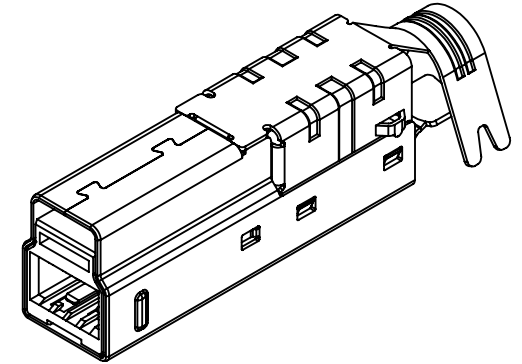

ISSUE NUMBER	
ORIGINAL	①



NOTE:
ELECTRICAL SPECIFICATIONS:
VOLTAGE RATING: 30V MAX.
CURRENT RATING: 1.8A PER PIN 1 & PIN 4
0.25A FOR OTHER CONTACTS
CONTACT RESISTANCE: 30mΩ MAX. FOR PIN 1 & PIN 4
50mΩ MAX FOR OTHER CONTACTS
INSULATOR RESISTANCE: 100MΩ min.
DIELECTRIC WITHSTANDING VOLTAGE: 100V AC
OPERATING TEMPERATURE: -20°C ~ 85°C

MATERIAL & FINISH:
SHELL: STAINLESS STEEL, NICKEL PLATING
HOUSING: PA66, WHITE IN COLOUR, UL94V-0
CONTACTS: COPPER ALLOY, T=0.25
50µ" GOLD PLATED

690 SERIES PLUGS USB TYPE-B CABLE END		ACAD REFERENCE NO.: 691F209-X90-7XX	
		DRAWN: C.B	DATE: December 19, 2020
EDAC TORONTO, ONTARIO CANADA YOUR CONNECTION TO QUALITY & SERVICE		CHECKED:	DATE:
		SCALE: 2:1	SHEET 1 OF 1
THESE DRAWINGS AND SPECIFICATIONS ARE THE PROPERTY OF EDAC INC., AND SHALL NOT BE REPRODUCED, OR COPIED OR USED AS THE BASIS FOR THE MANUFACTURE OR SALE OF APPARATUS WITHOUT WRITTEN PERMISSION.			DRAWING NUMBER: 691F209-X90-7XX
			PART NUMBER: 691F209-990-770
			ISSUE 1



THIS SERIES FULLY CONFORMS TO
THE EUROPEAN UNION DIRECTIVES
2011/65/EU FOR RoHS COMPLIANCY.