

TOLERANCE UNLESS OTHERWISE SPECIFIED	
.X	±0.25
.XX	±0.13
.XXX	±0.05

THIS IS A C.A.D. GENERATED DRAWING
DO NOT MAKE MANUAL REVISIONS TO MASTER.

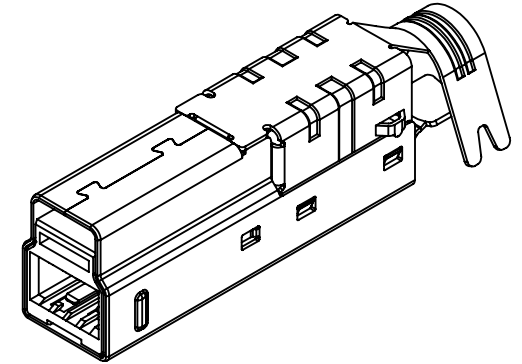

ISSUE NUMBER	
ORIGINAL	①



NOTE:
ELECTRICAL SPECIFICATIONS:
VOLTAGE RATING: 30V MAX.
CURRENT RATING: 1.8A PER PIN 1 & PIN 4
 0.25A FOR OTHER CONTACTS
CONTACT RESISTANCE: 30mΩ MAX. FOR PIN 1 & PIN 4
 50mΩ MAX FOR OTHER CONTACTS
INSULATOR RESISTANCE: 100MΩ min.
DIELECTRIC WITHSTANDING VOLTAGE: 100V AC
OPERATING TEMPERATURE: -20°C ~ 85°C

MATERIAL & FINISH:
SHELL: STAINLESS STEEL, NICKEL PLATING
HOUSING: PA66, BLUE IN COLOUR, UL94V-0
CONTACTS: COPPER ALLOY, T=0.25
 50µ" GOLD PLATED



THIS SERIES FULLY CONFORMS TO
THE EUROPEAN UNION DIRECTIVES
2011/65/EU FOR RoHS COMPLIANCY.



YOUR CONNECTION TO QUALITY & SERVICE

EDAC INC
TORONTO, ONTARIO
CANADA

THESE DRAWINGS AND SPECIFICATIONS
ARE THE PROPERTY OF EDAC INC., AND
SHALL NOT BE REPRODUCED, OR COPIED
OR USED AS THE BASIS FOR THE
MANUFACTURE OR SALE OF APPARATUS
WITHOUT WRITTEN PERMISSION.

690 SERIES PLUGS USB TYPE-B CABLE END

ACAD REFERENCE NO.: 691F209-X90-7XX	
DRAWN: C.B	DATE: December 19, 2020
CHECKED:	DATE:
SCALE: 2:1	SHEET 1 OF 1
DRAWING NUMBER: 691F209-X90-7XX	ISSUE
PART NUMBER: 691F209-990-772	1