

TOLERANCE UNLESS OTHERWISE SPECIFIED	
.X	±0.25
.XX	±0.15
.XXX	±0.05

THIS IS A C.A.D. GENERATED DRAWING
DO NOT MAKE MANUAL REVISIONS TO MASTER.

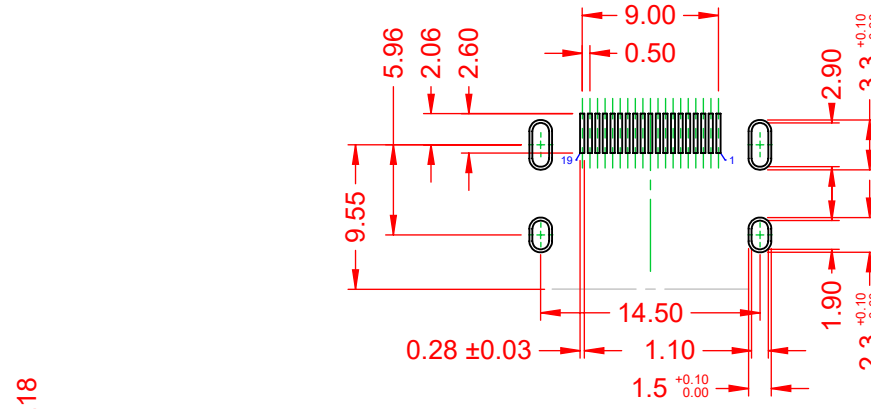

ISSUE NUMBER	
ORIGINAL	①

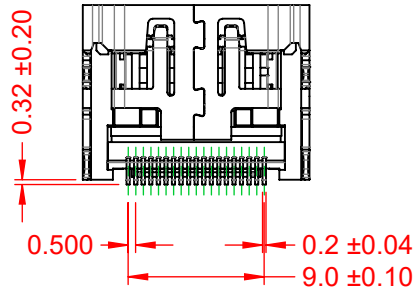
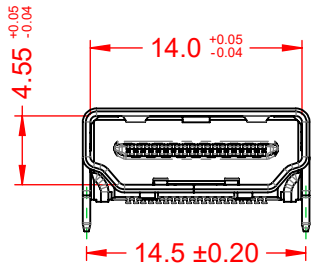
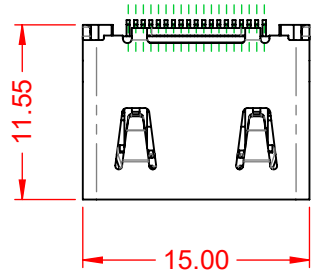

RECOMMENDED P.C.B LAYOUT
CONNECTOR SIDE / TOP VIEW
TOLERANCE: ±0.05

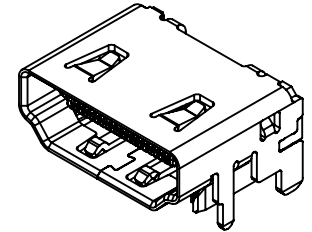
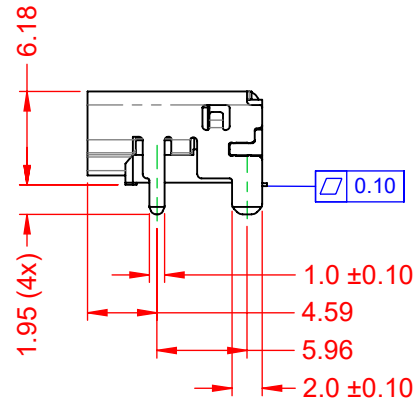



NOTE:

ELECTRICAL SPECIFICATIONS:

- CURRENT RATING: 0.5A
- VOLTAGE RATING: 40V AC
- CONTACT RESISTANCE: 10mΩ MAX.
- DIELECTRIC WITHSTANDING VOLTAGE: 300V AC/ 1 MINUTE
- INSULATOR RESISTANCE:
 - A) UNMATED: 100MΩ min. @ 500 VDC
 - B) MATED: 10M min. @ 150 VDC
- OPERATING TEMPERATURE: -20°C~85°C
- STORAGE TEMPERATURE: -20°C~65°C

MATERIAL & FINISH:

- SHELL: COPPER ALLOY, NICKEL PLATED
- HOUSING: LCP, BLACK IN COLOUR, UL94V-0
- CONTACTS: COPPER ALLOY, 30µ" GOLD PLATED

HDMI 2.1 CONNECTOR - RIGHT ANGLE SMT		ACAD REFERENCE NO.: 694A619-X64-011	
		DRAWN: C.B	DATE: January 4, 2021
CHECKED:	DATE:	SCALE: 2:1	SHEET 1 OF 1
 EDAC INC TORONTO, ONTARIO CANADA YOUR CONNECTION TO QUALITY & SERVICE		DRAWING NUMBER: 694A619-X64-011	
		PART NUMBER: 694A619-664-011	
 THIS SERIES FULLY CONFORMS TO THE EUROPEAN UNION DIRECTIVES 2011/65/EU FOR RoHS COMPLIANCY.		ISSUE 1	

THESE DRAWINGS AND SPECIFICATIONS
ARE THE PROPERTY OF EDAC INC., AND
SHALL NOT BE REPRODUCED, OR COPIED
OR USED AS THE BASIS FOR THE
MANUFACTURE OR SALE OF APPARATUS
WITHOUT WRITTEN PERMISSION.