

TOLERANCE UNLESS OTHERWISE SPECIFIED	
.X	±0.25
.XX	±0.13
.XXX	±0.05

THIS IS A C.A.D. GENERATED DRAWING
DO NOT MAKE MANUAL REVISIONS TO MASTER.

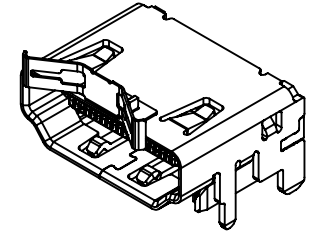

ISSUE NUMBER	
ORIGINAL	①

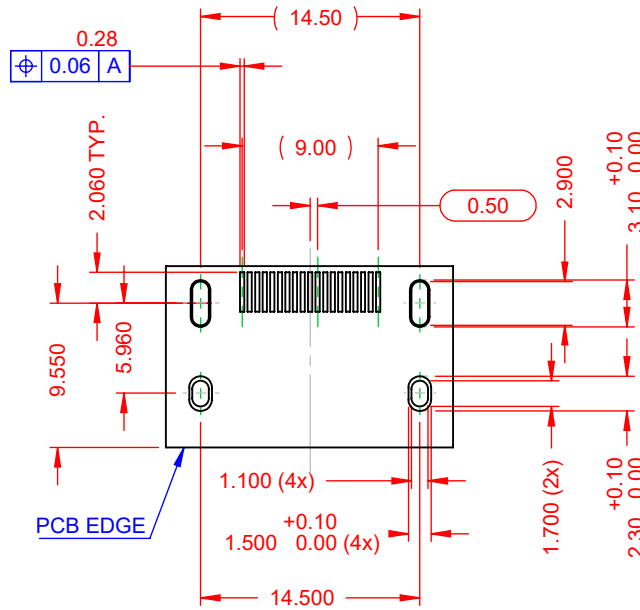
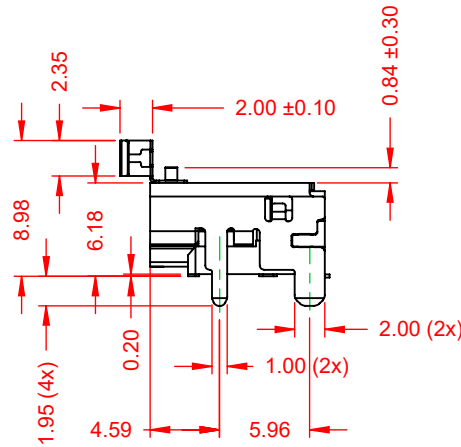
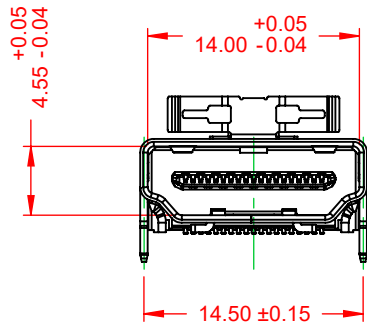
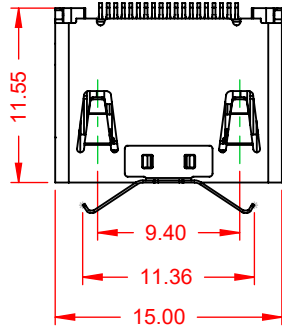

NOTE:

ELECTRICAL SPECIFICATIONS:

CURRENT RATING:	0.5A
VOLTAGE RATING:	40V
CONTACT RESISTANCE:	10mΩ MAX.
DIELECTRIC WITHSTANDING VOLTAGE:	500V AC/ 1 MINUTE
INSULATOR RESISTANCE:	
A) UNMATED	100MΩ min. @ 500 VDC
B) MATED	10MΩ min. @ 150 VDC
OPERATING TEMPERATURE:	-20°C~85°C
STORAGE TEMPERATURE:	-20°C~65°C

MATERIAL & FINISH:

SHELL:	COPPER ALLOY, NICKEL PLATED
HOUSING:	LCP, BLACK IN COLOUR, UL94V-0
CONTACTS:	COPPER ALLOY, 5μ" GOLD PLATED



THIS SERIES FULLY CONFORMS TO
THE EUROPEAN UNION DIRECTIVES
2011/65/EU FOR RoHS COMPLIANCY.



YOUR CONNECTION TO QUALITY & SERVICE

EDAC INC
TORONTO, ONTARIO
CANADA

THESE DRAWINGS AND SPECIFICATIONS
ARE THE PROPERTY OF EDAC INC., AND
SHALL NOT BE REPRODUCED, OR COPIED
OR USED AS THE BASIS FOR THE
MANUFACTURE OR SALE OF APPARATUS
WITHOUT WRITTEN PERMISSION.

**690 SERIES RECEPTACLES HDMI
TYPE-A R/ANGLE SMT - STANDARD**

ACAD REFERENCE NO.: 694D119EX64-011	
DRAWN: C.B	DATE: January 8, 2021
CHECKED:	DATE:
SCALE: 2:1	SHEET 1 OF 1
DRAWING NUMBER: 694D119EX64-011	ISSUE
PART NUMBER: 694D119E164-011	1