

TOLERANCE UNLESS OTHERWISE SPECIFIED	
.X	±0.25
.XX	±0.13
.XXX	±0.05

THIS IS A C.A.D. GENERATED DRAWING  
DO NOT MAKE MANUAL REVISIONS TO MASTER.



ISSUE NUMBER

ORIGINAL

1

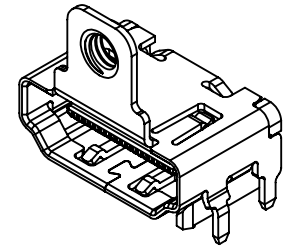
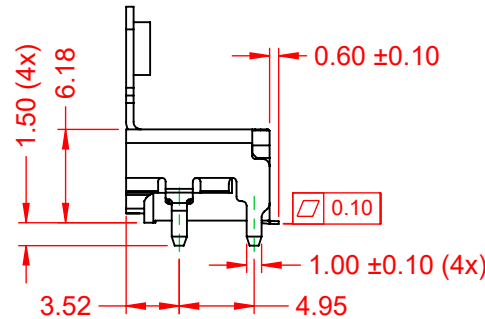
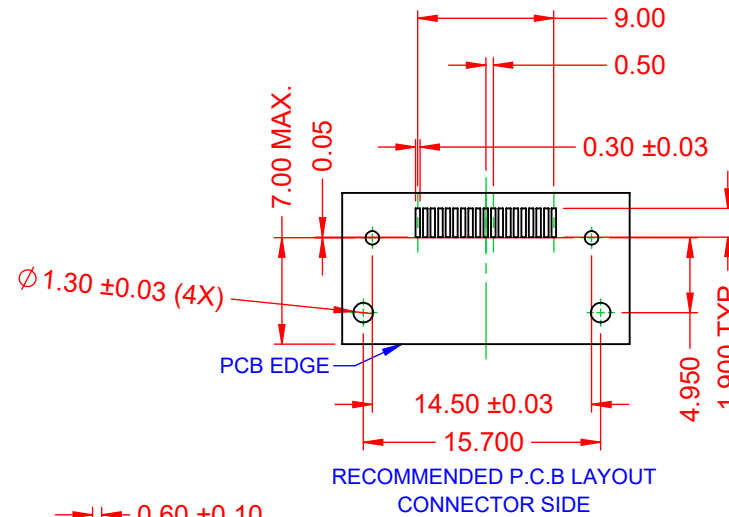
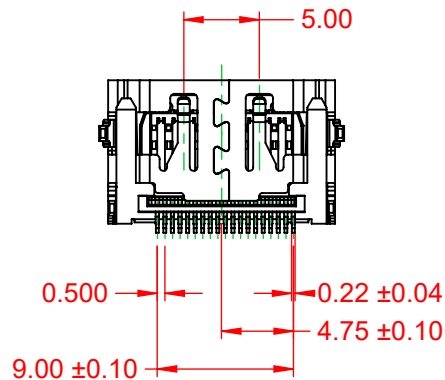
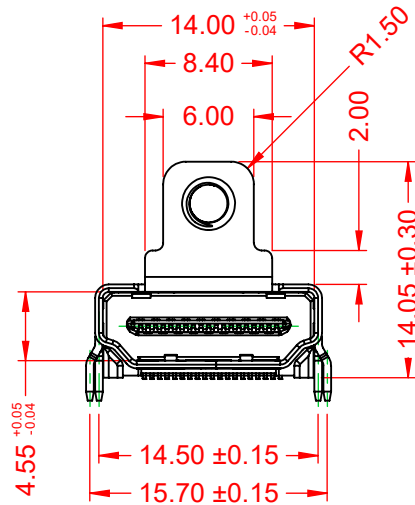
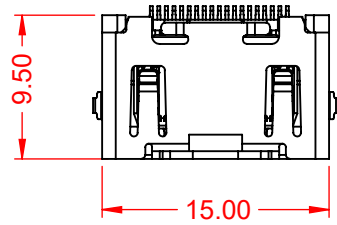

**NOTE:**

**ELECTRICAL SPECIFICATIONS:**

CURRENT RATING:	0.5A
VOLTAGE RATING:	40V
CONTACT RESISTANCE:	10mΩ MAX.
DIELECTRIC WITHSTANDING VOLTAGE:	300V AC/ 1 MINUTE
INSULATOR RESISTANCE:	
A) UNMATED	100MΩ min. @ 500 VDC
B) MATED	10M min. @ 150 VDC
OPERATING TEMPERATURE:	-20°C~85°C
STORAGE TEMPERATURE:	-20°C~65°C

**MATERIAL & FINISH:**

SHELL: STEEL, NICKEL PLATED  
HOUSING: LCP, BLACK IN COLOUR, UL94V-0  
CONTACTS: COPPER ALLOY, 30µ" GOLD PLATED



THIS SERIES FULLY CONFORMS TO  
THE EUROPEAN UNION DIRECTIVES  
2011/65/EU FOR RoHS COMPLIANCY.



YOUR CONNECTION TO QUALITY & SERVICE

**690 SERIES RECEPTACLES HDMI  
TYPE-A R/A SMT - M3 MOUNTING**

EDAC INC  
TORONTO, ONTARIO  
CANADA

THESE DRAWINGS AND SPECIFICATIONS  
ARE THE PROPERTY OF EDAC INC., AND  
SHALL NOT BE REPRODUCED, OR COPIED  
OR USED AS THE BASIS FOR THE  
MANUFACTURE OR SALE OF APPARATUS  
WITHOUT WRITTEN PERMISSION.

ACAD REFERENCE NO.: 694E119-X63-611	
DRAWN: C.B	DATE: January 4, 2021
CHECKED:	DATE:
SCALE: 2:1	SHEET 1 OF 1
DRAWING NUMBER: 694E119-X63-611	ISSUE
PART NUMBER: 694E119-663-611	1