

THIS IS A C.A.D. GENERATED DRAWING
DO NOT MAKE MANUAL REVISIONS TO MASTER

ORIGINAL

TOLERANCE UNLESS OTHERWISE SPECIFIED	
X	±0.20
XX	±0.10
XXX	±0.05

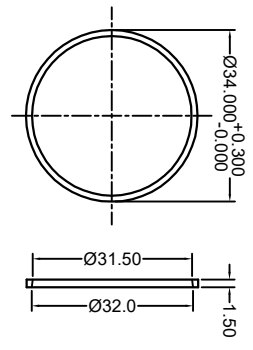
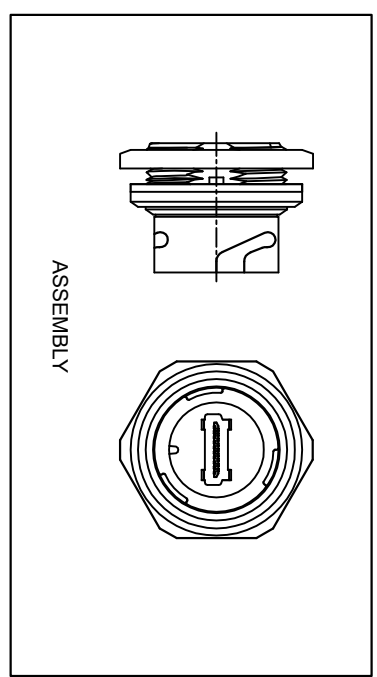

RING

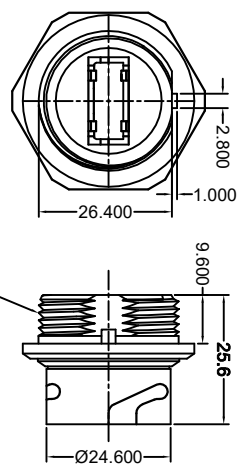

M28*1.5
BODY

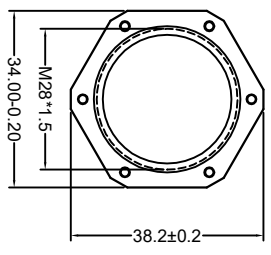
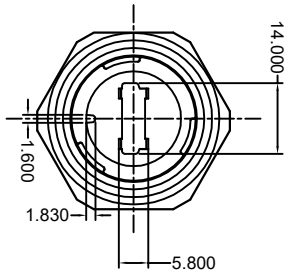

NUT

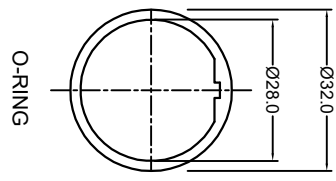
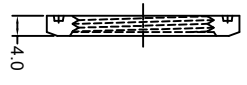

O-RING

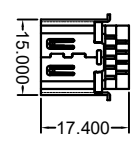
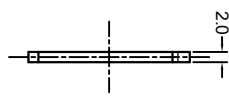

HDMI

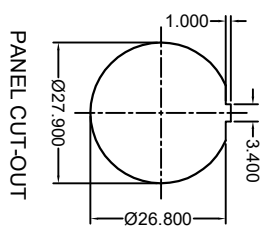
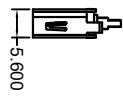

PANEL CUT-OUT

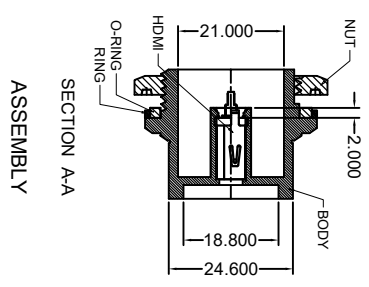

SECTION A-A
ASSEMBLY

NOTES:

MATERIAL:

- BODY: PBT, BLACK COLOUR, UL94V-0
- RING: PBT, BLACK COLOUR, UL94V-0
- O-RING: SILICONE, BLACK COLOUR
- NUT: PBT, BLACK COLOUR, UL94V-0
- HDMI: BRONZE, GOLD FLASH PLATING ON CONTACT AREA, MATTE TIN ON SOLDER AREA, ALL OVER NICKEL UNDER-PLATING
- CONTACT: BRASS, GOLD FLASH PLATING ON CONTACT AREA, ALL OVER NICKEL UNDER-PLATING
- SHELL: BRASS, GOLD FLASH PLATING ON CONTACT AREA, ALL OVER NICKEL UNDER-PLATING

OPERATING TEMPERATURE: -20°C ~ 85°C

- CURRENT RATING: 0.5A
- VOLTAGE RATING: 40V
- WATERPROOFING: IPX8

WATERPROOF HDMI BLACK TYPE A,
PANEL MOUNT (FEMALE)

EDRHC
EDAC INC
TORONTO, ONTARIO
CANADA
YOUR CONNECTION TO QUALITY & SERVICE

THESE DRAWINGS AND SPECIFICATIONS ARE THE PROPERTY OF EDAC INC. AND SHALL NOT BE REPRODUCED OR COPIED OR USED AS THE BASIS FOR THE MANUFACTURE OR SALE OF APPARATUS WITHOUT WRITTEN PERMISSION.

ACAD REFERENCE NO.:	694-W19-260-015	
DRAWN: N.B.	DATE:	JUN 28/2021
CHECKED: R.S.M.	DATE:	JUN 28/2021
SCALE: (IN C.A.D. 1:1)	SHEET	1 OF 1
DRAWING NUMBER: 694-W19-260-015	ISSUE	
PART NUMBER: 694-W19-260-015	1	



THIS SERIES FULLY CONFORMS TO
THE EUROPEAN UNION DIRECTIVES
2011/65/EU FOR ROHS COMPLIANCY.