

TOLERANCE UNLESS OTHERWISE SPECIFIED	
0-10	±0.20
10-30	±0.30
30-100	±0.40

THIS IS A C.A.D. GENERATED DRAWING
DO NOT MAKE MANUAL REVISIONS TO MASTER.

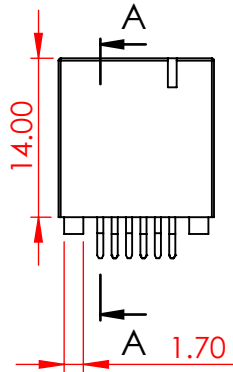

ISSUE NUMBER	
ORIGINAL	①
ADD CODE 99	
J.L.	MAR.22/2024 ②

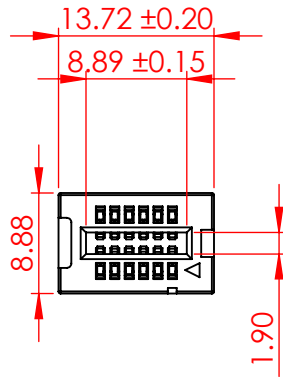

0.60
POINT OF
CONTACT

7.62
CARD SLOT

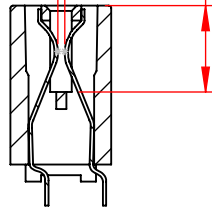

SECTION A-A
SCALE 3 : 2

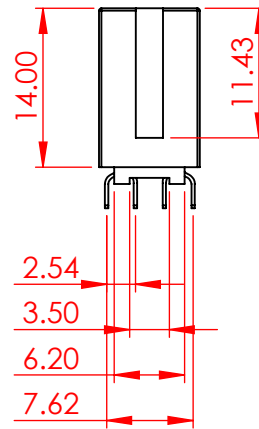

SPECIFICATIONS:

MATERIAL: HI-TEMP THERMOPLASTIC, PPS
CONTACT: COPPER ALLOY
PLATING: GOLD FLASH PLATING ON CONTACT AREA
 TIN PLATING ON SOLDERING AREA

ELECTRICAL
VOLTAGE RATING: 250 VAC RMS
CURRENT RATING: 1A
DIELECTRIC
WITHSTANDING VOLTAGE: 500VAC RMS 60Hz FOR 60s
INSULATION RESISTANCE: 1000 MEGA OHMS MIN AT 500VDC
CONTACT RESISTANCE: 30 mOHMS MAX

MECHANICAL
RETENTION FORCE: 460g MIN PER CONTACT
INSERTION FORCE: 230g MAX PER CONTACT PAIR
WITHDRAWAL FORCE: 15g MIN PER CONTACT PAIR

ENVIRONMENTAL
TEMPERATURE RANGE: -55°C TO +105°C



THIS SERIES FULLY CONFORMS TO
THE EUROPEAN UNION DIRECTIVES
2011/65/EU FOR RoHS COMPLIANCY.



YOUR CONNECTION TO QUALITY & SERVICE

EDAC INC
TORONTO, ONTARIO
CANADA

THESE DRAWINGS AND SPECIFICATIONS
ARE THE PROPERTY OF EDAC INC., AND
SHALL NOT BE REPRODUCED, OR COPIED
OR USED AS THE BASIS FOR THE
MANUFACTURE OR SALE OF APPARATUS
WITHOUT WRITTEN PERMISSION.

802 SERIES CARD EDGE CONNECTOR

ACAD REFERENCE NO.:	802 Assembly	UNIT: MM
DRAWN:	J.L.	DATE: 06/06/23
CHECKED:	R.S.M.	DATE: 04/09/24
SCALE:	3:2	SHEET 1 OF 2
DRAWING NUMBER:	802-012-221-201	ISSUE
PART NUMBER:	802-012-221-201	2

No. of Positions	Contact Code				
	Contact Code 21	Contact Code 58	Contact Code 99		
			Mounting Code 01	Mounting Code 05	Mounting Code 06
Dimension A		Dimension C			
4	1.27	1.27	1.27	5.08	N/A
6	2.54	2.54	2.54	6.35	N/A
8	3.81	3.81	3.81	7.62	7.62
10	5.08	5.08	5.08	8.89	8.89
12	6.35	6.35	6.35	10.16	10.16
14	7.62	7.62	7.62	11.43	N/A
16	8.89	8.89	8.89	12.70	12.70
20	11.43	11.43	11.43	15.24	15.24
22	12.70	12.70	12.70	16.51	N/A
24	13.97	13.97	13.97	17.78	N/A
26	15.24	15.24	15.24	19.05	N/A
30	17.78	17.78	17.78	21.59	N/A
32	19.05	19.05	19.05	22.86	N/A
36	21.59	21.59	21.59	25.40	N/A
40	24.13	24.13	24.13	27.94	27.94
48	29.21	29.21	29.21	33.02	N/A
50	30.48	30.48	30.48	34.29	34.29
52	31.75	31.75	31.75	35.56	N/A
60	36.83	36.83	36.83	40.64	40.64
68	41.91	N/A	41.91	45.72	N/A
70	43.18	N/A	43.18	46.99	N/A
80	49.53	49.53	49.53	53.34	53.34
100	62.23	N/A	62.23	66.04	N/A
110	68.58	N/A	68.58	72.39	N/A
120	74.93	N/A	74.93	78.74	78.74
124	77.47	N/A	77.47	81.28	N/A

N/A = NOT AVAILABLE



THIS SERIES FULLY CONFORMS TO THE EUROPEAN UNION DIRECTIVES 2011/65/EU FOR RoHS COMPLIANCY.



YOUR CONNECTION TO QUALITY & SERVICE

EDAC INC
TORONTO, ONTARIO
CANADA

THESE DRAWINGS AND SPECIFICATIONS ARE THE PROPERTY OF EDAC INC., AND SHALL NOT BE REPRODUCED, OR COPIED OR USED AS THE BASIS FOR THE MANUFACTURE OR SALE OF APPARATUS WITHOUT WRITTEN PERMISSION.

TOLERANCE UNLESS OTHERWISE SPECIFIED	
0-10	±0.20
10-30	±0.30
30-100	±0.40

THIS IS A C.A.D. GENERATED DRAWING
DO NOT MAKE MANUAL REVISIONS TO MASTER.



ISSUE NUMBER

SEE PAGE 1

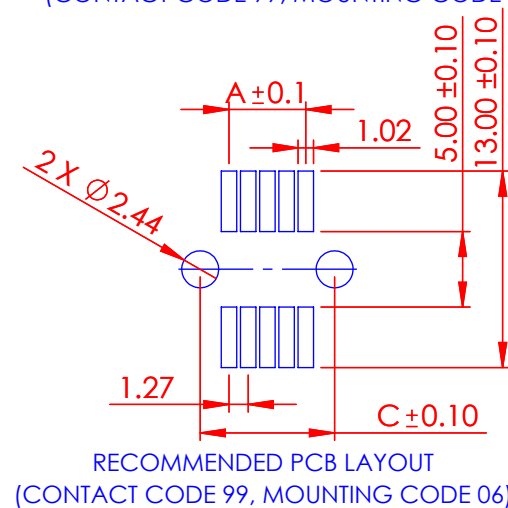
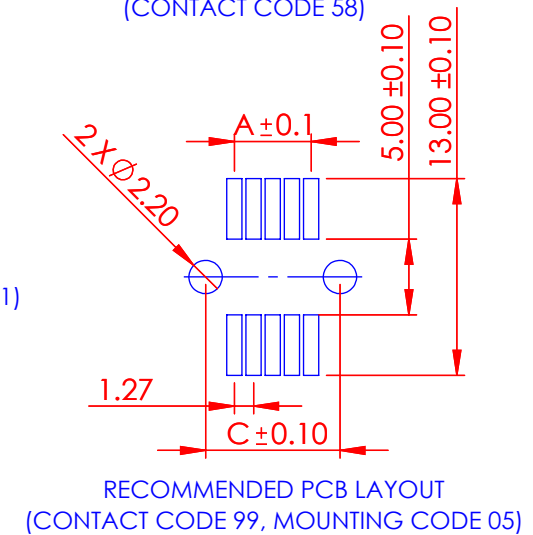
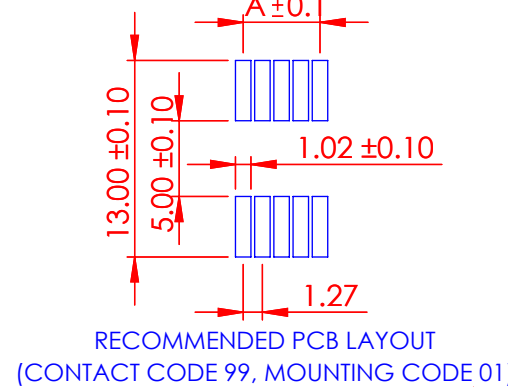
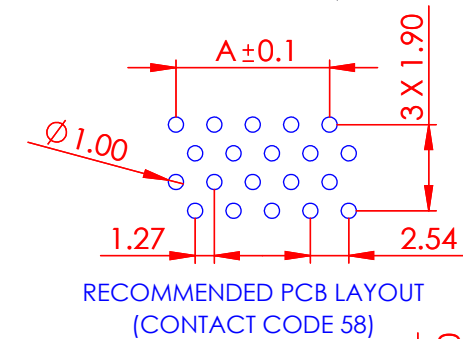
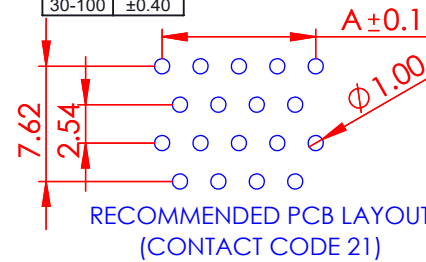

802-012-221-201

MOUNTING CODE

CONTACT CODE

802 SERIES CARD EDGE CONNECTOR

ACAD REFERENCE NO.:	802 Assembly	UNIT: MM
DRAWN:	J.L.	DATE: 06/06/23
CHECKED:	R.S.M.	DATE: 04/09/24
SCALE:	1:1	SHEET 2 OF 2
DRAWING NUMBER:	802-012-221-201	ISSUE
PART NUMBER:	802-012-221-201	2