

TOLERANCE UNLESS OTHERWISE SPECIFIED	
.X	±0.25
.XX	±0.13
.XXX	±0.05

THIS IS A C.A.D. GENERATED DRAWING
DO NOT MAKE MANUAL REVISIONS TO MASTER.

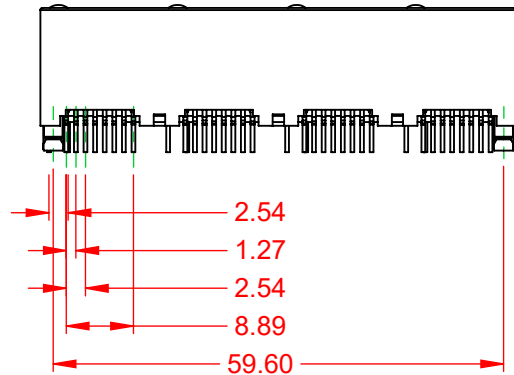

ISSUE NUMBER	①
ORIGINAL	

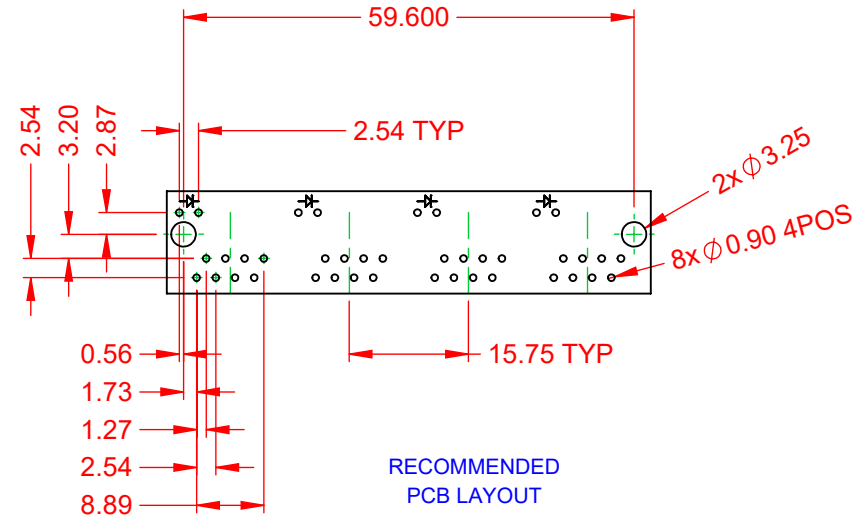
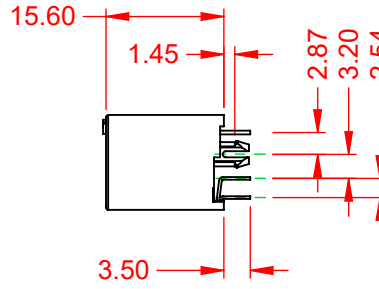
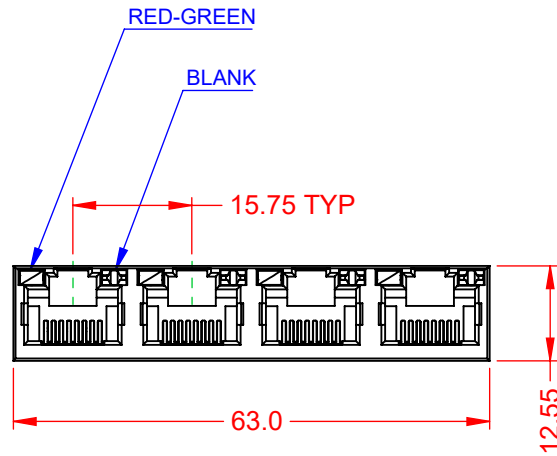

NOTES:

- MATERIALS:**
INSULATOR: PBT, BLACK, UL 94V-0
CONTACT: PHOSPHOR BRONZE, SELECT GOLD FLASH PLATING ON CONTACT AREA
TIN ON TAILS OVER NICKEL
- VOLTAGE RATING:** 150 VAC RMS
- CURRENT RATING:** 1.5 AMPS @25°C
- CONTACT RESISTANCE:** 20mΩ MAX
- INSULATOR RESISTANCE:** 1000MΩ MIN @ 500V DC
- DIELECTRIC WITHSTANDING:** 1000V AC CONTACT TO CONTACT @0.5mA 50Hz OR 60Hz 60s
- DURABILITY:** 750 CYCLES MIN
- MATING/UNMATING FORCE:** 30N/3.06KG MAX
- RETENTION STRENGTH:** 50N MIN FOR 60s ±5s
- OPERATING TEMP:** -40°C TO +85°C
- STORAGE TEMP:** -40°C TO +85°C RELATIVE HUMIDITY <80%

MATES WITH MODULAR PLUG CONFORMING TO FCC PART 68, SUBPART F.

RJ45, VERTICAL PCB MOUNT, 4 PORTS

ACAD REFERENCE NO.: J2W Assembly	
DRAWN: Y.Z	DATE: November 25, 2019
CHECKED:	DATE:
SCALE: 2:1	SHEET 1 OF 1
DRAWING NUMBER: J2W Assembly	ISSUE
PART NUMBER: J2W048821P60031	1



THIS SERIES FULLY CONFORMS TO THE EUROPEAN UNION DIRECTIVES 2011/65/EU FOR RoHS COMPLIANCY.



EDAC INC
TORONTO, ONTARIO
CANADA
YOUR CONNECTION TO QUALITY & SERVICE

THESE DRAWINGS AND SPECIFICATIONS ARE THE PROPERTY OF EDAC INC., AND SHALL NOT BE REPRODUCED, OR COPIED OR USED AS THE BASIS FOR THE MANUFACTURE OR SALE OF APPARATUS WITHOUT WRITTEN PERMISSION.