

THIS IS A C.A.D. GENERATED DRAWING
DO NOT MAKE MANUAL REVISIONS TO MASTER.

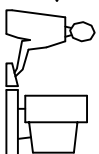

ISSUE NUMBER
ORIGINAL
①

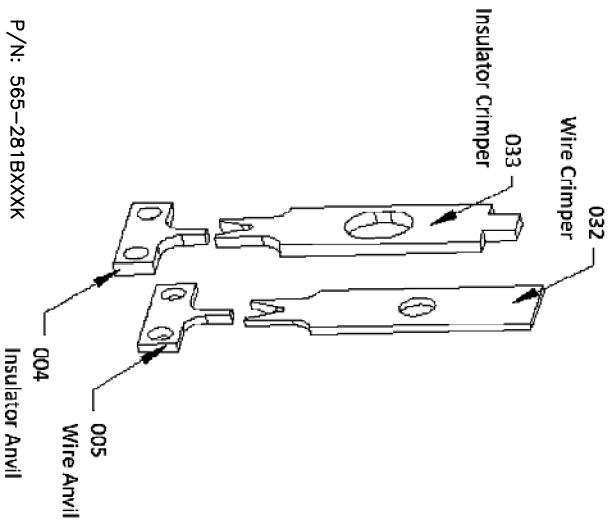
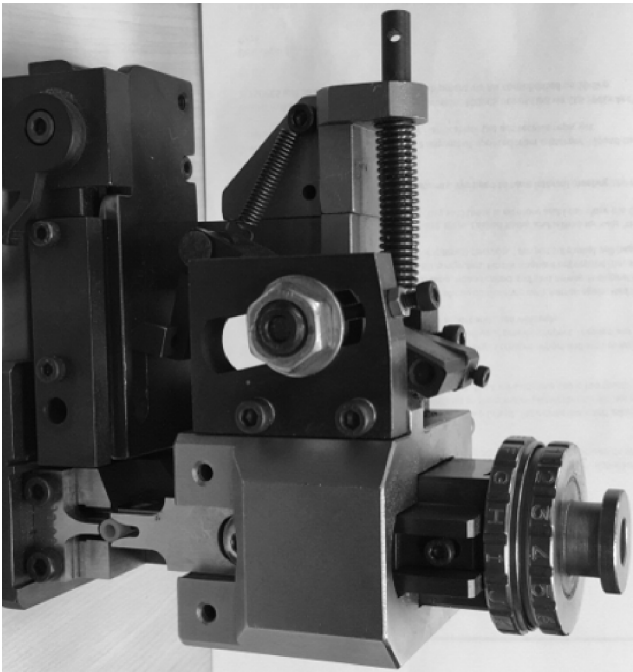

PRESS TYPE	K PRESS
STROKE LENGTH	30.00 MM
SHUT HEIGHT	119.55 MM
AWG	20-28

REPLACEMENT PUNCH & DIE PARTS			
INSULATOR ANVIL	WIRE ANVIL	WIRE CRIMPER	INSULATOR CRIMPER
565-281B004K	565-281B005K	565-281B032K	565-281B033K

NOTES:

- 1- THIS APPLICATOR IS DESIGNED TO BE USED ON A K CRIMPING MACHINE.
- 2- THIS APPLICATOR IS DESIGNED FOR CRIMPING EDAC CONTACT P/N 565-290-721.
- 3- FOR THE DEFINITION OF STROKE LENGTH AND SHUT HEIGHT, APPLICATOR SETUP AND OPERATING INSTRUCTION, PLEASE REFER TO DOCUMENT "APPLICATOR INSTRUCTION MANUAL K PRESS".

K PRESS APPLICATOR FOR 565-290-721

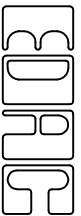

EDAC INC
TORONTO, ONTARIO
CANADA

YOUR CONNECTION TO QUALITY & SERVICE

THESE DRAWINGS AND SPECIFICATIONS ARE THE PROPERTY OF EDAC INC. AND SHALL NOT BE REPRODUCED, OR COPIED OR USED AS THE BASIS FOR THE MANUFACTURE OR SALE OF APPARATUS WITHOUT WRITTEN PERMISSION.

ACAD REFERENCE NO. 565-280-752K

DRAWN: K.L. DATE: OCT.29/2020

CHECKED: R.S.M. DATE: OCT.29/2020

SCALE: N.T.S. SHEET 1 OF 1

DRAWING NUMBER

565-280-752K

ISSUE
1